



Catalog

ABB industrial drives ACS800, single drives, 0.75 to 6000 hp

Power and productivity
for a better world™



Contents

ABB industrial drives

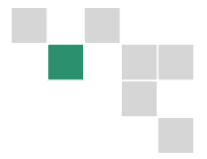

1

Product series

2

Single Drives

3

Hardware options

4

Control connections and communications

5

Application software and programming

6

PC Tools

7

Summary of features and options

8

Services and support

9

Contact and web information



ABB industrial drives.....	4	1
Direct Torque Technology	5	
Single drive main features	6	
Technical specification	8	
ACS800 Product Description	9	

Wall-mounted drive, ACS800-U1	10	2
Cabinet-built drive, ACS800-PC.....	12	
Free-standing drive, ACS800-U2	14	
Cabinet-built drive, ACS800-U7	16	
Cabinet-built drive, ACS800-07.....	18	
Liquid-cooled drive, ACS800-07LC.....	20	
Wall-mounted regenerative drive, ACS800-U11	22	
Cabinet-built regenerative drive, ACS800-17.....	24	
Wall-mounted ultra low harmonic drive, ACS800-U31	26	
Cabinet-built ultra low harmonic drive, ACS800-37	28	

Brake options	30	3
EMC filters	34	
du/dt filters	36	
Sine filter options	38	

Standard user interface		4
Control panel.....	39	
Standard I/O.....	40	
Options		
Optional I/O.....	41	
Fieldbus control	42	
Remote monitoring and diagnostics tool	43	

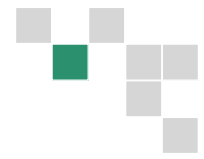
Standard application software	44	5
Optional application software		
Control solutions for different applications	45	

DriveSize.....	48	6
DriveAP.....	49	
DriveWindow 2.....	50	
DriveWindow Light 2	51	

Table	52	7
-------------	----	----------

Service and Support	54	8
---------------------------	----	----------

www.abb-drives.com	59	9
--------------------------	----	----------

ABB industrial drives

ACS800

U1
PC
U2
U7/07
U11/17
U31/37

XXXX

X

+

XXXX



ABB industrial drives

ABB industrial drives are designed for industrial applications, and especially for applications in process industries such as the converting, pulp & paper, metals, mining, cement, power, chemical, and oil & gas industries. ABB industrial drives are highly flexible AC drives that can be configured to meet the precise needs of industrial applications, and therefore order-based configuration is an integral part of the offering. These drives cover a wide range of powers and voltages, including industrial voltages up to 690 V. ABB industrial drives come with a wide range of built in options. A key feature of these drives is programmability, which makes adaptation to different applications easy.

Industrial design

ABB industrial drives are designed with current ratings to be used in industrial environments for applications requiring high overloadability. The heart of the drive is DTC, Direct Torque Control, that provides high performance and significant benefits: e.g. accurate static and dynamic speed and torque control, high starting torque and use of long motor cables. Built in drive options make the installation work fast and easy. The robust enclosures and cabinets, with a wide range of enclosure classes, as well as power terminals, are designed for harsh environments.

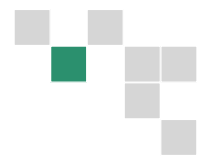
One of the most significant design criteria of ABB industrial drives has been long lifetime. Wearing parts such as fans and capacitors have been selected accordingly. This means - together with extensive protection features - excellent reliability in demanding industrial applications.

DTC Motor Control

Direct Torque Control (DTC) developed by ABB has improved motor control accuracy without the requirement of speed feedback device. Accurate speed and torque control of the manufacturing process optimizes the quality of the end product. Many applications no longer require additional speed feedback when the ACS800 with DTC is used.

Industrial^{IT} enabled

ABB industrial drives are Industrial^{IT} enabled. This guarantees the user that ABB industrial drives can be easily integrated into ABB Industrial IT systems.

Single drives

The single drive configuration contains a rectifier, DC link and an inverter in one single AC drive unit.

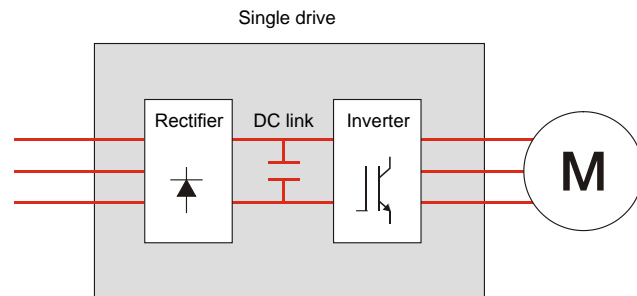

The single drives are complete AC drives that can be installed without any additional cabinet or enclosure. The single drives are available as wall-mounted, free-standing and cabinet-built constructions. The standard protection class of the single drives is UL Type 1 and higher protection classes are available as an option.

Type Code

This is the unique reference number that clearly identifies your drive by construction, power rating voltage and selected options. By type code you can specify your drives from the wide range of available options, customer specific ones are added to the type code using the corresponding + code.

Direct Torque Control Technology



DTC Technology - key in the ACS800 family

Direct Torque Control is an optimized motor control method for AC drives that allows direct control of all the core motor variables. This opens up AC drive capabilities never before realized and offers benefits for all applications.

What is Direct Torque Control?

Direct Torque Control, DTC, is a revolutionary motor control method for AC drives which allows accurate control of both motor speed and torque without pulse encoder feedback from the motor shaft, down to zero speed. In DTC, stator flux and torque are used as primary control variables. The motor state calculations are updated by the high speed digital signal processor at 40,000 times a second in the advanced motor software model. Due to the continuous updating of the motor state and the comparison of the actual values to the reference values, every

single switching in the drive is determined separately. This feature will always produce the optimal switching combination and can instantly react to dynamic changes such as load shocks or power interruptions. In DTC, there is no need for a separate voltage and frequency controlled pulse width modulator.

Unequalled motor speed & torque control

Open loop dynamic speed control accuracy matches that of AC drives using closed loop flux vector control. The ACS800 delivers static speed control accuracy of 0.1% to 0.5% of nominal speed - more than adequate for most industrial applications. In applications requiring even more precise speed regulation, an optional pulse encoder can be used. With an open loop torque step rise time of less than 5 milliseconds - compared to over 100 ms in AC drives using sensorless flux vector control - the ACS800 AC drive is unbeatable.

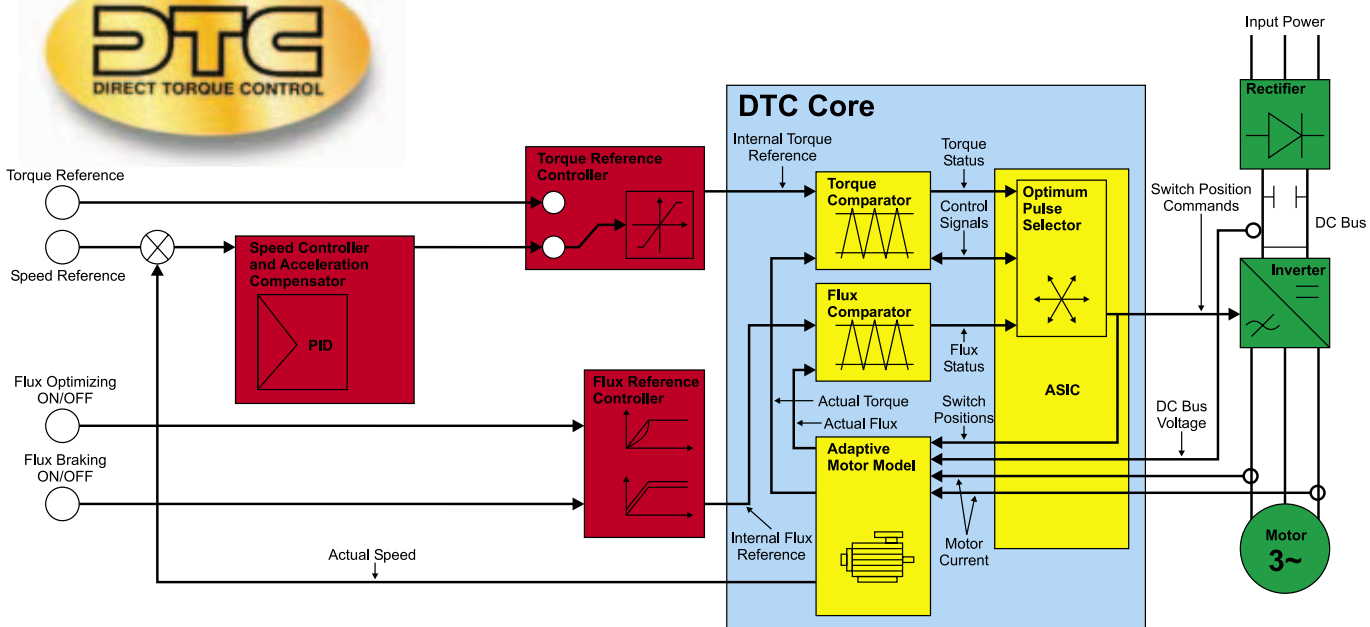
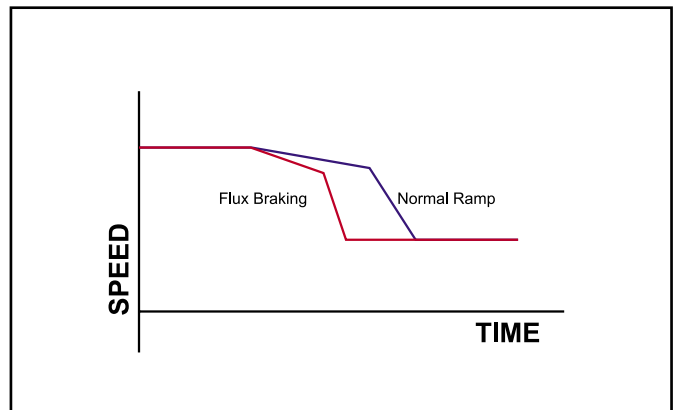
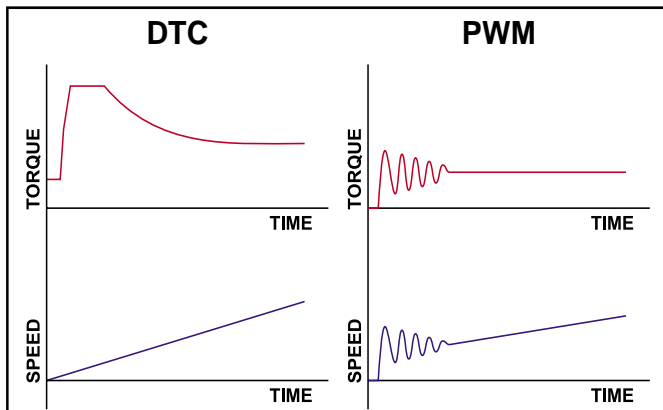

Single drive main features

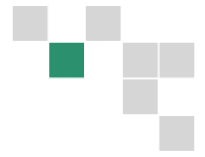

Features	Benefits	Notes
Compact and complete		
Compact size, everything integrated	Less space and installation work required.	No need to install extra components such as input chokes or EMC filter.
Built in harmonic filter in all ACS800 drives	Low harmonics, meaning less interference and less heating in cables and transformers. Filter also protects the drive from line side transients.	For the lowest harmonic level, ACS800-37 offers almost a harmonic free solution.
Wide range of options available	Standard solutions available from ABB to meet most customers application needs.	Custom made solutions are available in the ACS800-U7/07/17/37
Versatile braking options	Optimal braking options are always available. No need for an external braking chopper thus reducing size and installation cost.	Brake chopper built inside all frame sizes (standard/optional). Regenerative braking with ACS800-U11 and ACS800-17.
User interface		
User friendly customer interface	Easy and fast commissioning and operation.	Clear, alphanumeric display with start-up assistant that guides through the start-up procedure. Easy to use PC tools available for commissioning, maintenance, monitoring and programming.
Versatile connections and communications	Standard I/O covers most requirements. Connectable to commonly used fieldbuses.	Extensive standard and optional I/O.
Extensive programmability	Flexibility. Possible to replace relays or even a PLC in some applications.	Two levels of programmability: 1. Parameter programming (standard) 2. Adaptive programming (free block programming) - standard feature - more blocks available as options - all I/Os are programmable
Industrial design		
Wide power and voltage range	One product series can be used to meet all application needs, meaning less training and spare parts and standardized interface to drives.	0.75 to 3000 Hp 208 to 690 Vac
Wide range of robust enclosures available	Industrial suitable solutions available for different environments.	UL Type 1, UL Type 1 filtered, UL Type 12
Robust main circuit design	Suitable for heavy industrial use. Reliable. Long motor cables can be used without extra output filters.	Components dimensioned for heavy duty and long lifetime. Advanced thermal model allows high overloadability.

Single drive main features

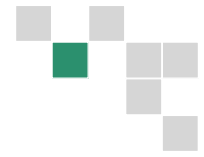

Features	Benefits	Notes
Industrial design		
Extensive protection features	Enhanced reliability, fewer process interruptions. Possibility to also protect motors and process.	Several adjustable limits to protect other equipment included.
Galvanic isolation of I/O	Safe and reliable operation without separate isolators and relays.	Isolated input signals and relay outputs as standard.
All terminals designed for industrial use	Sufficient size even for large aluminum cables. No need for special tools in I/O cabling.	
Worldwide approvals: CE, UL, cUL, CSA, C-Tick, GOST R	Products that can be used everywhere in the world.	
Right performance for every application		
DTC, accurate dynamic and static speed and torque control	Excellent process control even without speed feedback device - improved product quality, productivity, reliability and lower investment cost.	
DTC - allows high overloadability and gives high starting torque	Reliable, smooth start without overdimensioning the drive.	
DTC, fast control	No unnecessary trips or process interruptions.	Fast reaction to load or voltage variations prevents tripping. Rides through power interruptions by using kinetic energy of the load.
DTC, flux optimization and sophisticated motor model	Excellent motor and drive efficiency - cost savings for non-dynamic applications like pumps or fans.	Optimal flux in the motor reduces losses on applications where Dynamic Response requirements are minimal.
DTC, mechanics friendly	Less stress for mechanics improves reliability.	No shock torques. No torque ripple - minimized risk for torsional vibration. Active oscillation damping.
DTC, line supply control	High performance and robust control in active supply unit with programmable power factor.	Applies for ACS800-U11, ACS800-17, ACS800-U31, and ACS800-37
Made by ABB		
Global market leader in AC drives. Long experience.	Well proven, safe and reliable solutions. Application know-how.	
World wide service and support network	Professional support available around the world.	



Mains connection

Voltage and power range	3-phase, $U_{2IN} = 208$ to 240 V, $\pm 10\%$, except -U2,-U7,-07,-17,-37 3-phase, $U_{5IN} = 380$ to 500 V, $\pm 10\%$ 3-phase, $U_{7IN} = 525$ to 690 V, $\pm 10\%$ (600 V UL, CSA)
Short Circuit Current Rating (SCCR)	ACS800-U1,-U11,-U31 = 65ka ACS800-PC,-U2,-U7/07,-17,-37 = 100ka
Frequency	48 to 63 Hz
Nominal Impedance	3% Nominal Impedance R2-R3, DC Bus Choke R4 and greater, AC Reactor
Power factor	
ACS800-U1,-PC,-U2,-U7/07	$\cos\phi_1 = 0.98$ (fundamental) $\cos\phi = 0.93\text{...}0.95$ (total)
ACS800-U11,-17,-U31,-37	$\cos\phi_1 = 1$ (fundamental) $\cos\phi = 0.99$ (total)
Efficiency (at nominal power)	
ACS800-U1,-PC,-U2,-U7/07, 07LC	98%
ACS800-U11,-17,-U31,-37	97%

Motor connection

Voltage for > 500 V units	3-phase output voltage $0\text{...}U_{2IN}/U_{5IN}/U_{7IN}$ please see "Filter selection table for ACS800" under the du/dt filters on page 33
Frequency	$0\text{...}\pm 300$ Hz ($0\text{...}\pm 120$ Hz for -U7/-07 frames R6-R8 with du/dt filters and external du/dt filters)
Field weakening point	$8\text{...}300$ Hz
Motor control	ABB's exclusive Direct Torque Control (DTC)
Torque control	Torque step rise time
Open loop	<5 ms with nominal torque
Closed loop	<5 ms with nominal torque
	Non-linearity:
Open loop	$\pm 4\%$ with nominal torque
Closed loop	$\pm 1\%$ with nominal torque
Speed control	Static accuracy
Open loop	10% of motor slip
Closed loop	0.01% of nominal speed
	Dynamic accuracy
Open loop	0.3...0.4% sec. with 100% torque step
Closed loop	0.1...0.2% sec. with 100% torque step

Environmental

Ambient temperature	
Transport	-40...+70°C
Storage	-40...+70°C
Operation	-15...+50°C, no frost allowed 40...50°C at reduced output current (1% / 1°C)
Operation (ACS800-07LC)	0 to +55°C, no frost allowed +45 to 55°C, at reduced output current (1% / 1°C)
Cooling method	Dry clean air
Altitude	
0...1000 m	without derating
1000...4000 m	with derating ~ (1% / 100 m) (690 V units 1000...2000 m with derating)
Relative humidity	5 to 95%, no condensation allowed
Protection class	
UL Type 1	standard for -U1,-PC,-U2,-U7/07,07LC, -U11, -17,-U31,-37
UL Type 1 filtered	option for -U7/07,-17,-37
UL Type 12	option for -U1,-PC,-U7/07,07LC, -17,-37
Paint color	-PC,-U7/07,07LC, -17,-37: RAL 7035 -U1,-U11,-U2,-U31: NCS 1502-Y (RAL 90021, PMS 420 C)
Contamination levels	No conductive dust allowed
Storage	IEC60721-3-1, Class 1C2 (chemical gases), Class 1S2 (solid particles)
Transportation	IEC60721-3-2, Class 2C2 (chemical gases), Class 2S2 (solid particles)
Operation	IEC60721-3-3, Class 3C1/3C2* (chemical gases), Class 3S2 (solid particles)
C = chemically active substances	
S = mechanically active substances	

Product compliance

UL & cUL (508A or 508C) and CSA C22.2 NO.14-95, C-Tick, GOST R NEC 430.126(A)(2) Motor Overtemperature Protection
Quality assurance system ISO 9001 and
Environmental system ISO 14001
CE (Available)
Low Voltage Directive 73/23/EEC with amendment 93/68/EEC
Machinery Directive 98/37/EC
EMC Directive 89/336/EEC with amendment 93/68/EEC

EMC (according to EN 61800-3)

2nd environment, unrestricted distribution category C3 as standard in -07 (frame size nxR8i), 07LC, -17 and -37 (frame sizes R7i-nxR8i), option in the others
1st environment, restricted distribution category C2 as option up to 1000 A input current

NOTE: Available options are shown in the Summary of features options table. Please see pages 48-49.

ACS800 Product Description

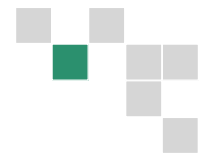

Wall-mounted drive, ACS800-U1

The wall-mounted drive, ACS800-U1 offers all that you need up to 200 Hp. All important features and options are built inside the drive: line choke, EMC filter, brake chopper etc. The user gets everything in a single and complete UL Type 1 or UL Type 12 package. Still the drive is also extremely small. A wide range of software alternatives makes this drive suitable for almost any application.

Cabinet-built drive, ACS800-PC

The cabinet built ACS800-PC is a US only construction using the industrial Rittal™ standard enclosure and is available from 125 to 600Hp at 480Vac. The ACS800-PC is a standardized package product that includes an input disconnect switch (circuit breaker) and class T input fuses. The drive is available in UL Type 1 enclosure up to 400Hp and optional in UL Type 12 enclosure up to 600Hp. The ACS800-PC offers a variety of options for factory installation including; I/O expansion, line contactor with E-Stop, and aux motor starter for motor cooling fan.

Free-standing drive, ACS800-U2

The free-standing drive, ACS800-U2, with power ratings from 125 to 600Hp, is available in an extremely compact UL Type 1 enclosure and uniquely offers two mounting directions. It also offers a wide range of built in options including, EMC filters, brake choppers, line apparatus such as fuse disconnect switch and contactor.

Cabinet-built drive, ACS800-U7/07

The cabinet-built drive, ACS800-U7/07 offers standardized configurations that can be adapted to any application. It covers a wide power range up to 3000 Hp and is very compact, the largest drive is only 10.5 feet wide. It is available with UL Type 1, UL Type 1 filtered and UL Type 12 protection classes. A wide range of built in options is available and application engineering services can be offered when customization is needed.

Regenerative drive, ACS800-U11/17

The ACS800 regenerative drive is equipped with an active supply unit. It offers a full performance regenerative drive in a single compact package. It is intended to drive applications where regenerative operation is required. All important features and options including an LCL line filter and EMC filter are built inside the drive.

The power ratings of the wall-mounted drive, ACS800-U11 start from 7.5 Hp and go up to 125 Hp. It is available in UL Type 1 protection class enclosure.

The power ratings of the cabinet-built drive, ACS800-17 start from 60 Hp and go up to 2,600 Hp. It is available with UL Type 1, UL Type 1 filtered and UL Type 12 protection classes. The cabinet-built drive has an extensive range of standardized configurations that can be adapted to any application.

Ultra low harmonic drive, ACS800-U31/37

The ultra low harmonic drive provides a unique ultra-low harmonic solution fully incorporated inside the drive. This design provides unmatched harmonic mitigation fulfilling IEEE519-1992 requirements at the drive input terminals without any additional external hardware. The active supply unit also allows the drive to operate at unity power factor and the harmonic mitigation is not effected by input line imbalances up to and exceeding 3% voltage imbalance.

The wall-mounted drive, ACS800-31 is available from 7.5 to 125 Hp in a UL Type 1 enclosure. The cabinet-built drive, ACS800-37 is available from 60 to 2,800 Hp with UL Type 1, UL Type 1 filtered and UL Type 12 protection classes.

Liquid-cooled drive, ACS800-07LC

ACS800 liquid-cooled frequency converter offers robust design for medium and high power applications. The compact size with a totally enclosed cabinet is optimized for harsh environmental conditions. The ACS800 liquid-cooled product series provides advanced reliability for both industrial and marine sector. Liquid cooling minimizes the noise level and improves heat transfer without a need for air conditioning equipment.

Wall-mounted drive

ACS800-U1, 1 to 200 Hp

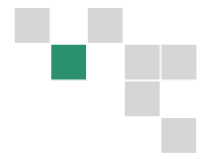

Compact and complete drive

The ACS800-U1 offers all that you need in a single, extremely small, wall-mounted package making it a compact and complete drive. The standard degree of protection is UL Type 1. Optional UL Type 12 allows full performance without derating. Power ratings start from 1 Hp heavy-duty rating and go up to 200 Hp continuous load rating. There are five different mechanical frame sizes covering the power range. Each frame size is optimized for performance, size and weight.

Everything inside

From the smallest to the largest ACS800-U1 there is an extensive range of built in features and options. Standard features include an AC Line Choke for harmonic filtering and drive protection, extensive and flexible I/O, user-friendly control panel with Start-up Assistant feature and a silent, long lifetime cooling fan. Brake chopper is included as standard in the two smallest frame sizes R2 and R3 as well as in the 690V R4 frame. In other frames the chopper is a built in option. Other built in options include EMC filters and extension modules for additional I/O, fieldbus and pulse encoder interface modules.

Main standard hardware features

- Wall mounting
- UL Type 1 protection class
- Compact design
- Harmonic filtering AC choke inside
- Input rectifier protection
- Brake chopper (in frame sizes R2-R3; R4 only 690 V)
- Long lifetime cooling fan and capacitors
- Extensive, programmable I/O with galvanically isolated inputs
- Three I/O and fieldbus extension slots inside
- Alphanumeric, multilingual control panel with start-up assistant feature
- Large power terminals allowing use of a wide range of cable sizes

Options for ACS800-U1

Built in options:

- UL Type 12 protection class
- Brake chopper (in frame sizes R4-R6)
- EMC filter for 1st environment, restricted distribution according to EN 61800-3
- EMC filter for 2nd environment, unrestricted distribution according to EN 61800-3
- Analog and digital I/O extension modules
- Fieldbus modules (Communication)
- Pulse encoder interface module
- Resolver interface (Limited SW Support)

External options:

- Brake resistor
- Output du/dt filters



NEMA 12 Enclosure

Ratings and dimensions

ACS800-U1



Type code	Frame size	Input A	I _{max} A	Normal Duty		Heavy-duty use		Noise Level dBA	Air flow ft³/min	Heat dissipation BTU/hr
				I _{2N} A	P _N Hp	I _{2HD} A	P _{HD} Hp			
3-phase supply voltage 208, 220, 230, 240. The power ratings are valid at nominal voltage, 240Vac (50 & 60Hz)										
ACS800-U1-0002-2	R2	5.2	8.2	6.6	1.5	4.6	1	62	21	350
ACS800-U1-0003-2	R2	6.5	10.8	8.1	2	6.6	1.5	62	21	350
ACS800-U1-0004-2	R2	9.2	13.8	11	3	7.5	2	62	21	410
ACS800-U1-0006-2	R3	18	24	21	5	13	3	62	41	550
ACS800-U1-0009-2	R3	24	32	27	7.5	17	5	62	41	680
ACS800-U1-0011-2	R3	31	46	34	10	25	7.5	62	41	850
ACS800-U1-0016-2	R4	38	62	42	15	31	10	62	61	1150
ACS800-U1-0020-2	R4	49	72	54	20 ⁽¹⁾	42	15 ⁽²⁾	62	61	1490
ACS800-U1-0025-2	R5	64	86	69	25	54	20 ⁽²⁾	65	99	1790
ACS800-U1-0030-2	R5	75	112	80	30	68	25 ⁽²⁾	65	99	2090
ACS800-U1-0040-2	R5	102	138	104	40 ⁽¹⁾	80	30 ⁽²⁾	65	99	2770
ACS800-U1-0050-2	R6	126	164	132	50	104	40	65	238	3370
ACS800-U1-0060-2	R6	153	202	157	60	130	50 ⁽²⁾	65	238	4050
ACS800-U1-0070-2	R6	190	282	192	75	154	60 ⁽²⁾	65	238	4910
3-phase supply voltage 380, 400, 415, 460, 480, 500. The power ratings are valid at nominal voltage, 480Vac 60Hz										
ACS800-U1-0004-5	R2	4.1	6.5	4.9	3	3.4	2	62	21	410
ACS800-U1-0005-5	R2	5.4	8.2	6.2	3	4.2	2	62	21	480
ACS800-U1-0006-5	R2	6.9	10.8	8.1	5	5.6	3	62	21	550
ACS800-U1-0009-5	R2	9.8	13.8	11	7.5	8.1	5	62	21	690
ACS800-U1-0011-5	R2	13	17.6	14	10	11	7.5	62	21	860
ACS800-U1-0016-5	R3	18	24	21	15	15	10	62	41	1150
ACS800-U1-0020-5	R3	24	32	27	20	21	15	62	41	1490
ACS800-U1-0025-5	R3	31	46	34	25	27	20	62	41	1790
ACS800-U1-0030-5	R4	40	62	42	30	34	25	62	61	2090
ACS800-U1-0040-5	R4	52	72	52	40	37	30 ⁽³⁾	62	61	2770
ACS800-U1-0050-5	R5	63	86	65	50	52	40	65	99	3370
ACS800-U1-0060-5	R5	77	112	79	60	65	50	65	99	4050
ACS800-U1-0070-5	R5	94	138	96	75	77	60	65	99	4910
ACS800-U1-0100-5	R6	121	164	124	100	96	75	65	238	6610
ACS800-U1-0120-5	R6	155	202	157	125	124	100	65	238	7890
ACS800-U1-0140-5	R6	179	282	180	150	156	125	65	238	9600
ACS800-U1-0205-5	R6	252	326	254	200	215	150	65	238	13670
3-phase supply voltage 525, 550, 575, 600, 690. The power ratings are valid at nominal voltage, 575Vac 60Hz										
ACS800-U1-0011-7	R4	10	14	11.5	10	8.5	5	62	61	1050
ACS800-U1-0016-7	R4	13	19	15	10	11	10	62	61	1200
ACS800-U1-0020-7	R4	19	28	20	15	15	10	62	61	1550
ACS800-U1-0025-7	R4	21	38	23	20	19	15	62	61	1850
ACS800-U1-0030-7	R4	29	44	30	25	22	20	62	61	2100
ACS800-U1-0040-7	R4	32	54	34	30	27	25	62	61	2400
ACS800-U1-0050-7	R5	45	68	46	40	34	30	65	99	2900
ACS800-U1-0060-7	R5	51	84	52	50	42	40	65	99	3450
ACS800-U1-0070-7	R6	70	104	73	60	54	50	65	238	4200
ACS800-U1-0100-7	R6	82	124	86	75	62	60	65	238	5650
ACS800-U1-0120-7	R6	103	172	108	100	86	75	65	238	6700
ACS800-U1-0145-7	R6	121	245	125	125	99	100	65	238	9084
ACS800-U1-0175-7	R6	150	245	155	150	131	125	65	238	11851
ACS800-U1-0205-7	R6	192	245	192	200	147	150	65	238	14275

NOTES:

- ⁽¹⁾ Overload may be limited to 5% at higher motor speeds (speed >90% motor base speed) by the internal power limit of the drive
- ⁽²⁾ Overload may be limited to 40% at higher motor speeds (speed >90% motor base speed) by the internal power limit of the drive
- ⁽³⁾ Rating not applicable for all motors. Available for some 4-pole 460V high efficiency NEMA motors.

I_{max} current available for 10 seconds at start.
 I_{2N} continuous base current at 40°C (104°F). Overload cycle 110%
 I_{2N} for 1 minute / 5 minutes allowed.
 I_{2nd} continuous base current at 40°C (104°F). Overload cycle 150%
 I_{2nd} for 1 minute / 5 minutes allowed.

- Current ratings do not change with different supply voltages.
- Horsepower ratings are based on NEMA motor ratings for typical 4-pole motors (1800 rpm). Check motor nameplate current for compatibility.
- All ACS800-U1 models come with a US conduit box (conduit plate in NEMA 12) as standard.

Enclosure

Degree of Protection:
 UL Type 1 (Standard)
 UL Type 12 (Optional)
 Paint color:
 NCS 1502-Y (RAL 90021/PMS 420C)

Frame size	UL Type 1					UL Type 12				
	H1 (in)	H2 (in)	W1 (in)	Depth (in)	Weight (lbs)	H1 (in)	W1 (in)	Depth (in)	Weight (lbs)	
R2	15.9	14.6	6.5	8.9	20	20.8	10.4	9.5	34	
R3	18.5	16.5	6.8	10.4	31	20.8	10.4	10.7	41	
R4	23.9	19.3	9.4	10.8	57	30.5	14.8	10.9	73	
R5	29.1	23.7	10.4	11.3	75	30.5	14.8	12.1	112	
R6	34.6	27.6	11.8	15.7	148	36.3	16.5	16.5	170	

H1 = Height with cable connection box H2=Height without cable connection box
 W1 = Width of the standard unit

Cabinet-built drive

ACS800-PC 125 up to 600 Hp

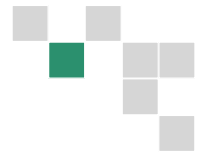

Customized solutions

The ACS800-PC is built in a robust cabinet designed for heavy-duty industrial applications with power ratings from 125 to 600 Hp. It is available in UL Type 1 and UL Type 12 enclosures.

Note: 450Hp and greater is only available in UL Type 12.

The ACS800-PC is a standardized packaged cabinet drive specifically designed for the US. This drive comes standard with a door interlock disconnect switch (circuit breaker) and current limiting fast acting Class T fuses. The disconnect switch is lockable in the off position. The ACS800-PC also offers a wide variety of options such as I/O expansion, Line Contactor with E-Stop and Aux Motor Starter.

Extensive range of features

The ACS800-PC has an extensive range of built in features and options. Typical option choices include extended I/O and fieldbus options, line contactor, EMC filtering, Aux Motor Starter, all mountable within the single cabinet.

Main standard features

- Compact design
- UL Type 1 protection class (0170-5 to 0400-5)
- UL Type 12 protection class (0440-5 to 0610-5)
- Built in harmonic filtering AC choke
- Common mode filters for motor protection
- Line disconnect switch (Circuit Breaker)
- Current Limiting Fast Acting Class T Fuses
- Extensive, programmable I/O
- Inputs galvanically isolated
- Long lifetime cooling fan and capacitors
- I/O and fieldbus extension slots inside
- Alphanumeric multilingual control panel with start-up assistant feature
- Top entry and exit of cables
- Coated Boards

Options for ACS800-PC

- Analog and digital I/O extension modules
- Brake chopper and resistor (resistor external)
- Customer terminal block
- EMC filter for 2nd environment, unrestricted distribution according to EN 61800-3 (standard in frame R8)
- Fieldbus modules
- UL Type 12 enclosure class
- Line contactor with emergency stop push button
- Output for fan motor (Aux Motor Starter)
- Pulse encoder interface module
- 1 or 2 thermistor relays
- 3 PT100 relays
- Resolver Interface (Limited SW Support)



Ratings and dimensions

ACS800-PC

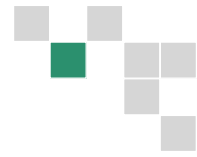

ACS800 - PC - XXXX - 5 + XXXX

Type code	Frame size	Input A	I_{max} A	Normal Duty		Heavy-duty use		Noise Level dBA	Air flow ft ³ /min	Heat Dissipation BTU/hr
				I_{2N} A	P_N Hp	I_{2HD} A	P_{HD} Hp			
3-phase supply voltage 380, 400, 415, 460, 480, 500. The power ratings are valid at nominal voltage, 480Vac 60Hz										
ACS800-PC-0170-5	R7	191	326	192	150	162	125	71	318	10100
ACS800-PC-0210-5	R7	243	384	240	200	192	150	71	318	12900
ACS800-PC-0270-5	R8	299	480	316	250	240	200	72	718	15350
ACS800-PC-0300-5	R8	336	568	361	300	302	250	72	718	18050
ACS800-PC-0320-5	R8	424	588	435	350	340	250	72	718	23250
ACS800-PC-0400-5	R8	498	588	510	400	370	300	72	718	26650
ACS800-PC-0440-5+B055	R8	543	840	545	450	490	400	72	718	25950
ACS800-PC-0490-5+B055	R8	590	840	590	500	515 ⁽¹⁾	450	72	718	27600
ACS800-PC-0550-5+B055	R8	669	1017	670	550	590 ⁽¹⁾	500	72	718	31100
ACS800-PC-0610-5+B055	R8	702	1017	704	600	590 ⁽¹⁾	500	72	718	33000

Frame size	Width in	Height UL Type 1 in	Height UL Type 12 in	Depth in	Weight lb
R7	31.7	83.7	93.6	24.4	730
R8	31.7	83.7	93.6	24.4	990

Enclosure

Degree of Protection:
UL Type 1
UL Type 12
Paint color:
Light beige RAL 7035 semi-gloss

NOTES:

⁽¹⁾ 50% overload is allowed if ambient temperature is 30°C or less, Overload is limited to 40% at 40°C

I_{max} current available for 10 seconds at start.

I_{2N} continuous base current at 40°C (104°F). Overload cycle 110% I_{2N} for 1 minute / 5 minutes allowed.

I_{2HD} continuous base current at 40°C (104°F). Overload cycle 150% I_{2HD} for 1 minute / 5 minutes allowed.

- Current ratings do not change with different supply voltages.

- Horsepower ratings are based on NEMA motor ratings for typical 4-pole motors (1800 rpm). Check motor nameplate current for compatibility.

Free-standing drive

ACS800-U2, 125 to 600 Hp

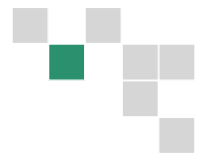

Compact and complete drive

The ACS800-U2 single drive is a unique, extremely compact bookshelf-style unit with a new innovative free-standing enclosure. The power ratings start from 125 Hp and go up to 600 Hp continuous load rating. It is available only in UL Type 1 protection class.

Fits anywhere

The ACS800-U2 drive is extremely compact without sacrificing user-friendliness. When using bookshelf mounting, even side-by-side installation is possible. In addition to bookshelf mounting, the ACS800-U2 offers the possibility for flat type (sideways) mounting, making it possible to optimize depth instead of width.

Everything inside

The ACS800-U2 has an extensive selection of built in features and options. Standard features include an AC choke for harmonic filtering and drive protection, extensive and flexible I/O, user-friendly control panel with Start-up Assistant feature and a silent, long lifetime cooling fan.

Built in options include EMC filters, brake chopper, common mode filter for motor protection and extension modules for additional I/O, fieldbus and pulse encoder interface modules.



Main standard hardware features

- Free-standing
- UL Type 1 protection class
- Line fuse disconnect switch
- Harmonic filtering AC choke inside
- Input rectifier protection
- Long lifetime cooling fan and capacitors
- Extensive, programmable I/O with galvanically isolated inputs
- Three I/O and fieldbus extension slots inside
- Alphanumeric, multilingual control panel with start-up assistant feature
- Large power terminals allowing the use of a wide range of cable sizes
- The ACS800-U2 includes the extension enclosure as standard

Options for ACS800-U2

Built in options:

- Brake chopper
- EMC filter for 1st environment, restricted distribution according to EN 61800-3
- EMC filter for 2nd environment, unrestricted distribution according to EN 61800-3
- Analog and digital I/O extension modules
- Fieldbus modules
- Pulse encoder interface module
- Resolver Interface (Limited SW Support)
- Common mode filters for motor protection

Options available with standard enclosure extension:

- Contactor with emergency stop push button
- 1 or 2 thermistor relays
- 3 PT100 relays
- Cable bottom entry and exit
- Customer terminal block

External options:

- Brake resistor
- Output du/dt filters

Ratings and dimensions

ACS800-U2

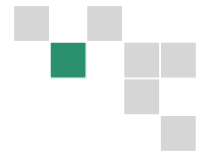

ACS800 - U2 - XXXX - 5 + XXXX

Type code	Frame size	Input A	I _{max} A	Normal Duty		Heavy-duty use		Noise Level dBA	Air flow ft ³ /min	Heat Dissipation BTU/hr
				I _{2N}	P _N	I _{2HD}	P _{HD}			
				A	Hp	A	Hp			
3-phase supply voltage 380, 400, 415, 460, 480, 500. The power ratings are valid at nominal voltage, 480Vac 60Hz										
ACS800-U2-0170-5	R7	191	326	192	150	162	125	71	318	10100
ACS800-U2-0210-5	R7	243	384	240	200	192	150	71	318	12900
ACS800-U2-0260-5	R7	291	432	286	200	224	150	71	318	15300
ACS800-U2-0270-5	R8	299	480	316	250	240	200	72	718	15350
ACS800-U2-0300-5	R8	336	568	361	300	302	152	72	718	18050
ACS800-U2-0320-5	R8	424	588	435	350	340	152	72	718	23250
ACS800-U2-0400-5	R8	498	588	510	400	370	300	72	718	25950
ACS800-U2-0440-5	R8	543	840	545	450	490	400	72	718	26650
ACS800-U2-0490-5	R8	590	840	590	500	515 ⁽¹⁾	450	72	718	27600
ACS800-U2-0550-5	R8	669	1017	670	550	590 ⁽¹⁾	500	72	718	31100
ACS800-U2-0610-5	R8	702	1017	704	600	590 ⁽¹⁾	500	72	718	33000

Frame size	UL Type 1				
	Height (in)	Width (in)	Depth (in)	Weight (lbs)	Weight without enclosure extension* (lbs)
R7	59.3	23.7	20.6	516	243
R8	79.7	31.5	24.5	992	529

*Weights are for the basic configuration with switch fuse, but without contactor and other options.

Enclosure

Degree of Protection:
UL Type 1 (Standard)
Paint color:
NCS 1502-Y (RAL 90021/PMS 420C)

NOTES:

⁽¹⁾ 50% overload is allowed if ambient temperature is 30°C or less, Overload is limited to 40% at 40°C

I_{max} current available for 10 seconds at start.

I_{2N} continuous base current at 40°C (104°F). Overload cycle 110% I_{2N} for 1 minute / 5 minutes allowed.

I_{2HD} continuous base current at 40°C (104°F). Overload cycle 150% I_{2HD} for 1 minute / 5 minutes allowed.

- Current ratings do not change with different supply voltages.

- Horsepower ratings are based on NEMA motor ratings for typical 4-pole motors (1800 rpm). Check motor nameplate current for compatibility.

- ACS800-02 product is no longer available. If the -02 type product is required, select ACS800-U2-xxxx-x+0C111 This will delete the extension enclosure and force Bottom Entry/Exit. Adding +H350+H352 is not required.

Cabinet-built drive

ACS800-U7 75 to 600 Hp

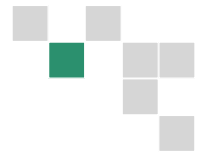

Customized solutions

The ACS800-U7 is built in a robust cabinet designed for heavy-duty industrial applications with power ratings from 75 to 600 Hp.

The ACS800-U7 offers a wide variety of standardized configurations to adapt to different application requirements, from line contactor to prevention of unexpected motor start.

If your application requires more, ABB's application engineering services can add special features to the standard product such as an additional cabinet for customer specific devices to ensure exact suitability for the application.

Extensive range of features

The ACS800-U7 has an extensive range of built in features and options. Typical option choices include extended I/O and fieldbus options, line contactor, EMC filtering, common mode filtering and du/dt (voltage rise) filtering, all mountable within the single cabinet.

Main standard features

- Compact design
- UL Type 1 protection class
- Built in harmonic filtering AC choke
- Common mode filters for motor protection
- Line fuse disconnect switch
- Extensive, programmable I/O
- Inputs galvanically isolated
- Long lifetime cooling fan and capacitors
- 3 I/O and fieldbus extension slots inside
- Alphanumeric multilingual control panel with start-up assistant feature
- Top entry and exit of cables

Options for ACS800-U7

- Analog and digital I/O extension modules
- Brake chopper and resistor
- Cabinet heater
- Customer terminal block
- Ground fault monitoring for ungrounded network
- EMC filter for 1st environment, restricted distribution according to EN 61800-3
- EMC filter for 2nd environment, unrestricted distribution according to EN 61800-3
- Fieldbus modules
- UL Type 1 Filtered and UL Type 12 enclosure classes
- Line contactor with emergency stop push button
- Output for aux fan motor
- Pulse encoder interface module
- Prevention of unexpected start up of motor
- 1 or 2 thermistor relays
- 3, 5 or 8 PT100 relays
- Resolver Interface (Limited SW Support)

Plus tailor made options through ABB's application engineering.



Ratings and dimensions

ACS800-U7



ACS800 - U7 - XXXX - 57 + XXXX

Type code	Frame size	Input A	I _{max} A	Normal Duty		Heavy-duty use		Noise Level dBA	Air flow ft ³ /min	Heat Dissipation BTU/hr
				I _{2N} A	P _N Hp	I _{2HD} A	P _{HD} Hp			
3-phase supply voltage 380, 400, 415, 460, 480, 500. The power ratings are valid at nominal voltage, 480Vac 60Hz										
ACS800-U7-0100-5	R6	121	164	124	100	96	75	63	238	6610
ACS800-U7-0120-5	R6	155	202	157	125	124	100	63	238	7890
ACS800-U7-0140-5	R6	180	282	180	150	156	125	63	238	9600
ACS800-U7-0170-5	R7	191	326	192	150	162	125	71	318	10100
ACS800-U7-0210-5	R7	243	384	240	200	192	150	71	318	12900
ACS800-U7-0260-5	R7	291	432	286	200	224	150	71	718	15300
ACS800-U7-0270-5	R8	299	480	316	250	240	200	72	718	15350
ACS800-U7-0300-5	R8	336	568	361	300	302	250	72	718	18050
ACS800-U7-0320-5	R8	424	588	435	350	340	250	72	718	23250
ACS800-U7-0400-5	R8	498	588	510	400	370	300	72	718	26650
ACS800-U7-0440-5	R8	543	840	545	450	490	400	72	718	25950
ACS800-U7-0490-5	R8	590	840	590	500	515 ⁽¹⁾	450	72	718	27600
ACS800-U7-0550-5	R8	669	1017	670	550	590 ⁽¹⁾	500	72	718	31100
ACS800-U7-0610-5	R8	702	1017	704	600	590 ⁽¹⁾	500	72	718	33000
3-phase supply voltage 525, 575, 600 V. The power ratings are valid at nominal voltage, 575Vac 60Hz										
ACS800-U7-0070-7	R6	95	104	73	60	54	50	65	238	4200
ACS800-U7-0100-7	R6	121	124	86	75	62	60	65	238	5650
ACS800-U7-0120-7	R6	155	172	108	100	86	75	65	238	6700
ACS800-U7-0140-7	R7	126	190	125	125	95	100	71	318	9600
ACS800-U7-0170-7	R7	156	263	155	150	131	125	71	318	12150
ACS800-U7-0210-7	R7	191	294	165/195 ⁽²⁾	150/200 ⁽²⁾	147	150	71	318	14550
ACS800-U7-0260-7	R7	217	326	175/212 ⁽²⁾	150/200 ⁽²⁾	163	150	71	318	16400
ACS800-U7-0320-7	R8	298	433	290	300	216	200	72	718	21050
ACS800-U7-0400-7	R8	333	548	344	350	274	250	72	718	22750
ACS800-U7-0440-7	R8	377	656	387	400	328	350	72	718	25300
ACS800-U7-0490-7	R8	423	775	426	450	387	400	72	718	28900
ACS800-U7-0550-7	R8	468	853	482	500	426	450	72	718	28350
ACS800-U7-0610-7	R8	533	964	537	500	482	500	72	718	33300

Frame size	Width in	Height		Depth in	Weight lb
		UL Type 1 in	UL Type 12 in		
R6	16.9	83.9	91.1	25.4	661.4
R7	32.7	83.9	91.1	25.4	881.8
R8	32.7	83.9	91.1	25.4	1102.31

Enclosure
 Degree of Protection:
 UL Type 1
 UL Type 1 Filtered, UL Type 12
 Paint color:
 Light beige RAL 7035 semi-gloss

NOTES:

⁽¹⁾ 50% overload is allowed if ambient temperature is 30°C or less, Overload is limited to 40% at 40°C

⁽²⁾ The higher rating is available when output frequency is above 41 Hz.

I_{max} current available for 10 seconds at start.

I_{2N} continuous base current at 40°C (104°F). Overload cycle 110% I_{2N} for 1 minute / 5 minutes allowed.

I_{2hd} continuous base current at 40°C (104°F). Overload cycle 150% I_{2hd} for 1 minute / 5 minutes allowed.

- Current ratings do not change with different supply voltages.

- Horsepower ratings are based on NEMA motor ratings for typical 4-pole motors (1800 rpm). Check motor nameplate current for compatibility.

Cabinet-built drive

ACS800-07, 500 to 3000 Hp

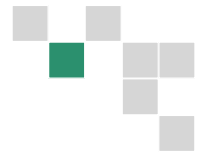

Customized solutions

The ACS800-07 is built in a robust cabinet designed for heavy industrial applications.

The ACS800-07 offers a wide variety of standardized configurations to adapt to different application requirements, from line contactor to prevention of unexpected motor start.

If your application requires more, ABB's application engineering services can add special features to the standard product such as an additional cabinet for customer specific devices to ensure exact suitability for the application.

Smart module concept

ACS800-07 drives consist of separate rectifier and inverter modules, which have plug-in power connectors providing easy maintenance and redundancy with parallel connected units. If one module becomes defective, the drive can continue running with reduced power after disconnecting the faulty module.

Extensive range of features

The ACS800-07 has an extensive range of built in features and options. Typical option choices include extended I/O and fieldbus options, line contactor, EMC filtering, common mode filtering and du/dt (voltage rise) output filtering, all mountable within the single cabinet.

Main standard features

- Compact design
- UL Type 1 protection class
- Built in harmonic filtering choke
- du/dt output filters
- Common mode filters for motor protection
- Line fuse disconnect switch
- Extensive, programmable I/O
- Inputs galvanically isolated
- Long lifetime cooling fan and capacitors
- 3 I/O and fieldbus extension slots inside
- Alphanumeric multilingual control panel with start-up assistant feature
- EMC filter for 2nd environment, unrestricted distribution according to EN 61800-3
- Top entry and exit of cables

Options for ACS800-07

- 6- or 12-pulse operation
- Analog and digital I/O extension modules
- Brake chopper and resistor
- Cabinet heater
- Customer terminal block
- Ground fault monitoring for ungrounded network
- EMC filter for 1st environment, restricted distribution according to EN 61800-3
- Fieldbus modules
- UL Type 1 Filtered and UL Type 12 enclosure classes
- Line contactor with emergency stop push button
- Output for aux fan motor
- Pulse encoder interface module
- Prevention of unexpected start up of motor
- 1 or 2 thermistor relays
- 3, 5 or 8 Pt100 relays
- Resolver Interface (Limited SW Support)

Plus tailor made options through ABB's application engineering group.

Ratings and dimensions

ACS800-07

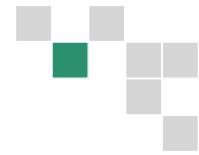

ACS800 - 07 - XXXX - 57 + XXXX

Type code	Frame size	Input A	I_{max} A	Normal Duty		Heavy-duty use		Noise Level dBA	Air flow ft ³ /min	Heat Dissipation BTU/hr
				I_{2N} A	P_N Hp	I_{2HD} A	P_{HD} Hp			
3-phase supply voltage 380, 400, 415, 460, 480, 500. The power ratings are valid at nominal voltage, 480Vac 60Hz										
ACS800-07-0760-5+C129+H359	1D4+2R8i	793	1321	848	700	660	550	73	1836	47800
ACS800-07-0910-5+C129+H359	2D4+2R8i	944	1524	1008	900	785	700	74	2260	58700
ACS800-07-1090-5+C129+H359	2D4+2R8i	1131	1882	1208	1000	941	800	74	2260	67900
ACS800-07-1210-5+C129+H359	2D4+2R8i	1233	1991	1317	1150	1026	900	74	2260	81200
ACS800-07-1540-5+A004+C129+H359	2D4+3R8i	1596	2655	1704	1500	1328	1150	75	2966	100300
ACS800-07-1820-5+A004+C129+H359	2D4+3R8i	1831	2956	1956	1750	1524	1250	76	3390	119400
ACS800-07-2310-5+A004+C129+H359	3D4+4R8i	2400	3901	2563	2250	1997	1750	76	4096	154900
3-phase supply voltage 525, 550, 575, 600, 690. The power ratings are valid at nominal voltage, 575Vac 60Hz										
ACS800-07-0750-7+C129+H359	1D4+2R8i	565	939	603	600	470	500	73	1836	47400
ACS800-07-0870-7+C129+H359	1D4+2R8i	655	1091	700	750	545	600	73	1836	58300
ACS800-07-1060-7+C129+H359	1D4+2R8i	795	1324	850	900	662	700	73	1836	62800
ACS800-07-1160-7+C129+H359	2D4+2R8i	856	1426	915	1000	713	800	74	2260	71000
ACS800-07-1500-7+C129+H359	2D4+3R8i	1131	1882	1208	1250	941	1000	75	2966	92100
ACS800-07-1740-7+C129+H359	2D4+3R8i	1271	2115	1357	1500	1058	1150	75	2966	110900
ACS800-07-2120-7+C129+H359	2D4+4R8i	1595	2654	1703	1850	1327	1400	76	3672	136800
ACS800-07-2320-7+A004+C129+H359	3D4+4R8i	1678	2792	1791	2000	1396	1500	76	4096	147700
ACS800-07-2900-7+A004+C129+H359	3D4+5R8i	2086	3472	2228	2400	1736	1900	77	4803	175700
ACS800-07-3190-7+A004+C129+H359	3D4+6R8i	2396	3987	2558	2800	1993	2250	78	5509	197900
ACS800-07-3490-7+A004+C129+H359	4D4+6R8i	2490	4144	2659	3000	2072	2300	78	5933	217000

Frame size	Width with line fuse switch & motor cabinet in	Height UL Type 1 in	Height UL Type 12 in	Depth top entry/exit in	Weight with line fuse switch lb
1xD4 + 2xR8i	83.9	83.9	91.1	25.4	2977
2xD4 + 2xR8i	99.6	83.9	91.1	25.4	3485
2xD4 + 3xR8i	111.4	83.9	91.1	25.4	3860
2xD4 + 4xR8i	127.2	83.9	91.1	25.4	4390
3xD4 + 3xR8i	135.0	83.9	91.1	25.4	4590
3xD4 + 4xR8i	150.8	83.9	91.1	25.4	5115
3xD4 + 5xR8i	158.7	83.9	91.1	25.4	5465
3xD4 + 6xR8i	190.2	83.9	91.1	25.4	5845
4xD4 + 6xR8i	198.0	83.9	91.1	25.4	6970

Enclosure

Degree of Protection:
UL Type 1
UL Type 1 Filtered, UL Type 12
Paint color:
Light beige RAL 7035 semi-gloss

NOTES:

I_{max} current available for 10 seconds at start.

I_{2N} continuous base current at 40°C (104°F). Overload cycle 110% I_{2N} for 1 minute / 5 minutes allowed.

I_{2HD} continuous base current at 40°C (104°F). Overload cycle 150% I_{2HD} for 1 minute / 5 minutes allowed.

- Current ratings do not change with different supply voltages.
- The rated current of the ACS800 must be greater than or equal to the rated motor current to achieve the rated motor power given in the table.
- Horsepower ratings are based on NEMA motor ratings for typical 4-pole motors (1800 rpm). Check motor nameplate current for compatibility.



ACS800-07-3190-7 3000 Hp drive

Diode supply and inverter units of nxR8i drives are on wheels providing quick and easy maintenance.

Liquid-cooled drive

ACS800-07LC, 350 to 6,000 Hp

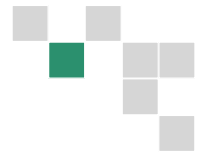

Ultimate solution for high power applications

The new liquid-cooled ACS800 frequency converter offers robust design for high power applications. The compact size with a totally enclosed cabinet is optimized for harsh environmental conditions. The liquid-cooled ACS800 product series provides advanced reliability for medium and high power applications.

The ACS800-07LC single drive is available from 350 HP up to 6,000 HP at 380 to 690 V supply voltages.

Advanced liquid cooling

The ACS800 liquid-cooled drive utilizes direct liquid cooling which makes the converter extremely compact and silent. Liquid cooling reduces the need for high power filtered air-cooling in the installation rooms. Along with the high efficiency, direct liquid cooling offers low noise and easy heat transfer without air filtering.

Customized solutions

The modular hardware design and advanced software features of the liquid-cooled single drive enable the most sophisticated drive solutions for both induction and permanent magnet motors. The design meets the international standards.

The ACS800-07LC product offering includes variety of standardized configurations to adapt to different application requirements. If your application requires more, ABB's application engineering services can add special features to the standard product. ABB's extensive application and product know-how is at your service.

Intelligence and high availability

The ABB ACS800 liquid-cooled series has a number of unique features as standard, and which are not available in previous generations of ABB drives. These include:

- Built in redundancy through parallel connected modules - each module is a complete three-phase inverter
- Ability to run with partial load even when one of the modules is not operating - enabling higher drive availability and greater process uptime.

With ABB drives, you get more than the most reliable equipment and systems. ABB drives are backed by our full service and support network, which covers field service and training as well as spare parts. This ensures reliable and economic operation under all conditions “Compact and easy” – are the watchwords to describe the entire ACS800 liquid-cooled drive range. They demonstrate how technology enables ABB to add more and more features into a shrinking space – and still give the benefits of easy installation, access and use.

Ratings and dimensions

ACS800-07LC

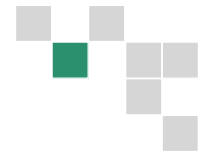

Ratings											
Type code	Frame Size	Input A (AC)	I _{max} A (AC)	Normal duty		Heavy-duty use		Noise level dBA	Dissipation to liquid kW	Liquid Qty g	Mass flow gpm
				I2N A	PN HP	I2HD A	PHD HP				
				3-phase supply voltage 380, 400, 415, 460, 480, 500. The power ratings are valid at nominal voltage, 480Vac 60Hz							
ACS800-07LC-0470-5	1xD3 + 1xR8i		673	524	450	408	350	55	8.7	1.7	8.5
ACS800-07LC-0550-5	1xD3 + 1xR8i		838	605	500	471	400	55	10	1.7	8.5
ACS800-07LC-0730-5	1xD3 + 1xR8i		1042	806	650	628	500	55	13	1.7	8.5
ACS800-07LC-0930-5	1xD4 + 2xR8i		1280	1027	900	800	650	56	16	2.1	12
ACS800-07LC-1070-5	1xD4 + 2xR8i		1589	1185	1000	924	750	56	19	2.1	12
ACS800-07LC-1430-5	1xD4 + 2xR8i		1996	1581	1400	1232	1100	56	25	2.1	12
ACS800-07LC-1590-5	1xD4 + 3xR8i		2344	1760	1550	1371	1200	57	29	3.7	15
ACS800-07LC-2120-5	2xD4 + 3xR8i		2943	2347	2100	1828	1600	58	36	3.7	20
ACS800-07LC-2790-5	2xD4 + 4xR8i		3885	3097	2800	2413	2200	58	49	4.2	24
ACS800-07LC-3470-5	3xD4 + 5xR8i		4830	3851	3500	3000	2700	59	60	5.8	32
ACS800-07LC-4150-5	3xD4 + 6xR8i		5801	4596	4200	3581	3200	60	73	6.3	36
3-phase supply voltage 525, 550, 575, 600, 690. The power ratings are valid at nominal voltage, 575Vac 60Hz.											
ACS800-07LC-0700-7	1xD3 + 1xR8i		872	560	600	436	450	55	12	1.7	8.5
ACS800-07LC-0940-7	1xD3 + 2xR8i		1182	759	800	591	600	56	17	2.1	12
ACS800-07LC-1070-7	1xD3 + 2xR8i		1344	863	950	672	700	56	19	2.1	12
ACS800-07LC-1370-7	1xD4 + 2xR8i		1710	1097	1200	855	950	56	22	2.1	12
ACS800-07LC-1590-7	1xD4 + 3xR8i		1996	1281	1400	998	1100	57	28	2.6	15
ACS800-07LC-2030-7	1xD4 + 3xR8i		2538	1629	1800	1269	1400	57	34	2.6	15
ACS800-07LC-2680-7	2xD4 + 4xR8i		3350	2150	2400	1675	1800	58	44	4.2	24
ACS800-07LC-3330-7	2xD4 + 5xR8i		4166	2673	3000	2083	2400	58	55	5.8	27
ACS800-07LC-3970-7	2xD4 + 6xR8i		4974	3191	3600	2487	2800	59	66	5.3	31
ACS800-07LC-4630-7	3xD4 + 7xR8i		5802	3723	4200	2901	3300	60	76	6.9	39
ACS800-07LC-5300-7	3xD4 + 8xR8i		6630	4255	4800	3315	3700	61	87	7.4	43
ACS800-07LC-5960-7	3xD4 + 9xR8i		7460	4787	5400	3730	4200	62	99	7.9	46
ACS800-07LC-6620-7	3xD4 + 10xR8i		8288	5319	6000	4144	4700	62	112	8.5	49

Frame Size	Height in	Width w/o LC unit in	Width with LC unit in	Depth in	Weight lbs
1xD3 + 1xR8i	78.9	28.7	40.6	25.4	1543
1xD3 + 2xR8i	78.9	36.6	48.4	25.4	1830
1xD4 + 2xR8i	78.9	36.6	48.4	25.4	1918
1xD4 + 3xR8i	78.9	44.5	56.3	25.4	2293
2xD4 + 3xR8i	78.9	60.2	83.9	25.4	3175
2xD4 + 4xR8i	78.9	72.0	95.7	25.4	3660
2xD4 + 5xR8i	78.9	79.9	103.5	25.4	4211
2xD4 + 6xR8i	78.9	87.8	111.4	25.4	4586
3xD4 + 5xR8i	78.9	95.7	119.3	25.4	4211
3xD4 + 6xR8i	78.9	103.5	127.2	25.4	4586
3xD4 + 7xR8i	78.9	115.4	139.0	25.4	6129
3xD4 + 8xR8i	78.9	123.2	146.9	25.4	6504
3xD4 + 9xR8i	78.9	131.1	154.7	25.4	6878
3xD4 + 10xR8i	78.9	142.9	166.5	25.4	7496

NOTES:

These ratings apply at 45 °C degrees ambient temperature. At higher temperatures (up to 55°C) the derating is 1% / 1 °C

Nominal Ratings:

I_{max} : maximum output current. Available for 10 seconds at start, otherwise as long as allowed by drive temperature.

NOTE: max. motor shaft power is 150% P_{nd}.

I_N continuous base current allowing 110% overload for 1 minute / 5 minutes.

I_{hd} continuous base current allowing 150% overload for 1 minute / 5 minutes.

The current ratings are the same regardless of the supply voltage within one voltage range.

- 1) Total height with marine supports is 82.2 inches
- 2) Pressure release lids require an additional 15.7 inches

Regenerative AC drive, wall-mounted

ACS800-U11, 7.5 to 125 Hp

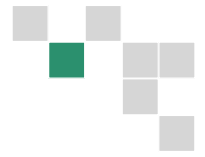

Wall-mounted regenerative drive

The ACS800-U11 is a wall-mounted drive equipped with an active supply unit. It offers a full performance regenerative drive in one compact package. The drive has extensive selection of built in features and options. The power ratings start from 7.5 Hp heavy-duty rating and go up to 125 Hp continuous rating. It is only available with UL Type 1 protection class.

Complete regenerative drive

The ACS800-U11 offers you a complete regenerative drive in a single, compact wall-mounted package. All the functions of a regenerative drive, such as an active supply unit, LCL line filter and charging circuitry, are integrated inside the drive. All this makes it possible to save installation time and space on the site, and also prevents installation mistakes as the drive is tested at the factory as a complete package.

Energy savings

The regenerative drive offers significant energy savings compared with other braking methods such as mechanical and resistor braking, as energy is fed back to the AC line network. No external brake resistor is needed, which translates into simplified installation and no electrical energy wasted as heat.

Main standard hardware features

- Wall-mounting
- UL Type 1 protection class
- LCL line filter inside
- Active supply unit inside
- Long lifetime cooling fan and capacitors
- Extensive, programmable I/O with galvanically isolated inputs
- Three I/O and fieldbus extension slots inside
- Alphanumeric, multilingual control panel with start-up assistant feature
- Large power terminals allowing the use of a wide range of cable sizes

Options for ACS800-U11

Built in options:

- EMC filter for 1st environment, restricted distribution according to EN 61800-3
- EMC filter for 2nd environment, unrestricted distribution according to EN 61800-3
- Analog and digital I/O extension modules
- Fieldbus modules
- Pulse encoder interface module
- Resolver Interface (Limited SW Support)

External options:

- Output du/dt filters



Ratings and dimensions

ACS800-U11

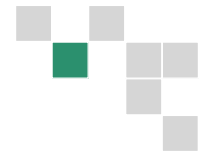

ACS800 - U11 - XXXX - 2 5 + XXXX

Type code	Frame size	Input A	I _{max} A	Normal Duty		Heavy-duty use		Noise Level dBA	Air flow ft ³ /min	Heat Dissipation BTU/hr
				I _{2N} A	P _N Hp	I _{2HD} A	P _{HD} Hp			
3-phase supply voltage 208, 220, 230, 240. The power ratings are valid at nominal voltage, 240Vac (50 & 60Hz)										
ACS800-U11-0011-2	R5	32	52	32	10	26	7.5	70	206	1730
ACS800-U11-0016-2	R5	44	68	45	15	38	10	70	206	2380
ACS800-U11-0020-2	R5	55	90	56	20	45	10	70	206	3110
ACS800-U11-0025-2	R5	70	118	69	25	59	15	70	206	3760
ACS800-U11-0030-2	R5	82	144	83	30	72	20	70	206	4500
ACS800-U11-0040-2	R6	112	168	114	40	84	25	73	238	5420
ACS800-U11-0050-2	R6	140	234	143	50	117	30	73	238	7260
ACS800-U11-0060-2	R6	157	264	157	60	132	40	73	238	8650
3-phase supply voltage 380, 400, 415, 460, 480, 500. The power ratings are valid at nominal voltage, 480Vac 60Hz										
ACS800-U11-0020-5	R5	29	52	29	20	25	15	70	206	2240
ACS800-U11-0025-5	R5	33	61	34	25	30	20	70	206	2600
ACS800-U11-0030-5	R5	44	68	45	30	37	25	70	206	3420
ACS800-U11-0040-5	R5	54	90	55	40	47	30	70	206	4140
ACS800-U11-0050-5	R5	65	118	67	50	57	40	70	206	4960
ACS800-U11-0060-5	R5	76	144	78	60	62	50	70	206	5980
ACS800-U11-0070-5	R6	112	168	114	75	88	60	73	238	8030
ACS800-U11-0100-5	R6	129	234	132	100	114	75	73	238	9570
ACS800-U11-0120-5	R6	145	264	156	125	125	100	73	238	11620
3-phase supply voltage 525, 575, 600. The power ratings are valid at nominal voltage, 575Vac 60Hz										
ACS800-U11-0060-7	R6	53	86	54	50	43	40	73	238	5980
ACS800-U11-0070-7	R6	73	120	75	60	60	50	73	238	8030
ACS800-U11-0100-7	R6	86	142	88	75	71	60	73	238	9570

Frame size	UL Type 1			
	Height (in)	Width (in)	Depth (in)	Weight (lbs)
R5	32.1	10.4	15.4	143
R6	38.2	11.8	17.3	220.5

Enclosure
Degree of Protection:
UL Type 1(Standard)
Paint color:
NCS 1502-Y (RAL 90021/PMS 420C)

NOTES:

- I_{max} current available for 10 seconds at start.
- I_{2N} continuous base current at 40°C (104°F). Overload cycle 110% I_{2N} for 1 minute / 5 minutes allowed.
- I_{2HD} continuous base current at 40°C (104°F). Overload cycle 150% I_{2HD} for 1 minute / 5 minutes allowed.
- Current ratings do not change with different supply voltages.
- Horsepower ratings are based on NEMA motor ratings for typical 4-pole motors (1800 rpm). Check motor nameplate current for compatibility.

Regenerative AC drive, cabinet-built

ACS800-17, 125 to 2600 Hp



Complete regenerative drive

The ACS800-17 offers you a complete regenerative drive in a single, compact cabinet-built package. The drive includes everything that is needed for regenerative operation, including line filter. The active supply unit allows full power flow both in motoring and regenerating modes.

Energy savings

Compared with other braking methods such as mechanical and resistor braking, the energy savings can be significant with the ACS800-17. The braking energy is returned to the AC Line network, not wasted as heat. Handling of waste heat may also be a problem if braking power is significant. As no external braking devices are needed with the ACS800-17, installation work is simpler and the space requirement for installation is less.

High performance

The ACS800-17 is especially suitable for demanding applications. Transition between motoring and generating is fast due to the patented DTC motor control method. The active supply unit is able to boost output voltage, which guarantees full motor voltage even when the supply voltage is below nominal.

The active supply unit combined with the DTC motor control can even compensate for fast variations in line voltage. There is no risk of fuse blow or component damage due to voltage drops in the network while regenerating.

Extensive range of features

Adaptation to different application requirements is possible by selecting from a wide range of standardized configurations. The cabinet-built drive series enables having a significant number of features and accessories as built in options.

Main standard features

- Compact design
- UL Type 1 protection class
- LCL line filter inside
- EMC filter for 2nd environment, unrestricted distribution according to EN 61800-3
- Main disconnect switch with aR fuses (ultra fast)
- Line contactor
- Withdrawable air circuit breaker (in frame size nxR8i)
- Du/dt filters (in frame size nxR8i)
- Coated boards
- Extensive, programmable I/O
- Long lifetime cooling fan and capacitors
- Inputs galvanically isolated
- 3 I/O and fieldbus extension slots inside
- Alphanumeric multilingual control panel with start-up assistant feature

Options for the ACS800-17

- Analogue and digital I/O extension modules
- ATEX approved motor protection
- Cabinet heater
- Customer terminal block
- du/dt output filters (frames R7i -R8i)
- Ground fault monitoring for ungrounded network
- EMC filter for 1st environment, restricted distribution according to EN 61800-3
- Fieldbus modules
- UL Type 1 Filtered & UL Type 12 enclosure classes
- Emergency stop, category 0 or 1
- Output for aux motor fan
- Pulse encoder interface module
- Prevention of unexpected start up of motor
- Top entry and exit of cables
- 1 or 2 thermistor relays
- 3, 5 or 8 PT100 relays
- Resolver Interface (Limited SW Support)

Plus tailor made accessories through ABB's application engineering.

Ratings and dimensions

ACS800-17

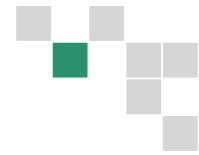

ACS800 - 17 - XXXX - 57 + XXXX

Type code	Frame size	Input A	I _{max} A	Normal Duty		Heavy-duty use		Noise Level dBA	Air flow ft ³ /min	Heat Dissipation BTU/hr
				I _{2N} A	P _N Hp	I _{2HD} A	P _{HD} Hp			
3-phase supply voltage 380, 400, 415, 460, 480, 500. The power ratings are valid at nominal voltage, 480Vac 60Hz										
ACS800-17-0070-5+C129	R6	112	168	114	75	88	60	73	295	8200
ACS800-17-0100-5+C129	R6	129	234	132	100	114	75	73	295	9600
ACS800-17-0120-5+C129	R6	145	264	156	125	125	100	73	295	11600
ACS800-17-0170-5+C129	R7i	180	291	192	150	156	125	74	765	20500
ACS800-17-0210-5+C129	R7i	220	356	240	200	183	150	74	765	27300
ACS800-17-0260-5+C129	R8i	270	438	302	250	226	150	75	1860	30700
ACS800-17-0320-5+C129	R8i	329	530	361	300	273	200	75	1860	37600
ACS800-17-0400-5+C129	R8i	410	660	437	350	340	250	75	1860	47600
ACS800-17-0460-5+C129	R8i	473	762	504	400	393	300	75	1860	54700
ACS800-17-0510-5+C129	R8i	536	863	571	450	445	350	75	1860	61500
ACS800-17-0580-5+C129	R8i	600	972	643	500	501	400	75	1860	75100
ACS800-17-0780-5+C129+H359	2xR8i	803	1294	856	700	667	550	77	3770	88800
ACS800-17-0870-5+C129+H359	2xR8i	900	1458	965	800	752	650	77	3770	109000
ACS800-17-1140-5+C129+H359	2xR8i	1176	1906	1261	1050	982	850	77	3770	147000
ACS800-17-1330-5+C129+H359	3xR8i	1379	2217	1467	1250	1143	1000	78	6030	157000
ACS800-17-1640-5+C129+H359	3xR8i	1746	2734	1809	1550	1409	1250	78	6030	219000
ACS800-17-2160-5+C129+H359	4xR8i	2304	3608	2387	2050	1860	1600	79	7530	287000
3-phase supply voltage 525, 550, 575, 600, 690. The power ratings are valid at nominal voltage, 575Vac 60Hz										
ACS800-17-0060-7+C129	R6	53	86	54	50	43	40	73	294	6142
ACS800-17-0070-7+C129	R6	73	120	75	60	60	50	73	294	8190
ACS800-17-0100-7+C129	R6	86	142	88	75	71	60	73	294	9554
ACS800-17-0160-7+C129	R7i	119	192	127	125	99	100	74	765	27300
ACS800-17-0200-7+C129	R7i	135	218	144	150	112	125	74	765	30700
ACS800-17-0260-7+C129	R8i	180	301	193	200	150	150	75	1860	41000
ACS800-17-0320-7+C129	R8i	250	417	268	250	209	200	75	1860	51200
ACS800-17-0400-7+C129	R8i	300	502	322	300	251	250	75	1860	61500
ACS800-17-0440-7+C129	R8i	344	571	367	350	286	300	75	1860	64900
ACS800-17-0540-7+C129	R8i	400	668	429	450	334	350	75	1860	71700
ACS800-17-0790-7+C129+H359	2xR8i	593	985	632	650	493	500	77	3770	120000
ACS800-17-0870-7+C129+H359	2xR8i	657	1091	700	750	545	600	77	3770	126000
ACS800-17-1050-7+C129+H359	2xR8i	784	1310	840	900	655	700	77	3770	143000
ACS800-17-1330-7+C129+H359	3xR8i	1001	1663	1067	1150	831	900	78	6030	184000
ACS800-17-1510-7+C129+H359	3xR8i	1164	1879	1206	1300	940	1050	78	6030	212000
ACS800-17-1980-7+C129+H359	4xR8i	1536	2480	1591	1750	1240	1350	79	7530	280000
ACS800-17-2780-7+C129+H359	5xR8i	2091	3472	2228	2450	1736	1900	79	10550	362000
ACS800-17-2940-7+C129+H359	6xR8i	2280	3680	2362	2600	1840	2000	79	11300	413000

NOTE: C129 captures US requirements

Frame size	Width in	Height UL Type 1 in	Height UL Type 12 in	Depth top entry/exit ^{B)} in	Weight lb
R6	16.9	83.9	91.1	25.4	550
R7i	24.8	83.9	91.1	25.4	880
R8i	48.4 ^{A)}	83.9	91.1	25.4	2090
2xR8i	107.5	83.9	91.1	25.4	4982
3xR8i	139.0	83.9	91.1	25.4	6746
4xR8i	178.3	83.9	91.1	25.4	7937
5xR8i	225.6	83.9	91.1	25.4	10538
6xR8i	243.4	83.9	91.1	25.4	10869

^{A)} 60.2 in if equipped with 1st environment filter and common motor terminal.

^{B)} The depth without the handle.

NOTES:

I_{max} current available for 10 seconds at start.

I_{2N} continuous base current at 40°C (104°F). Overload cycle 110% I_{2N} for 1 minute / 5 minutes allowed.

I_{2hd} continuous base current at 40°C (104°F). Overload cycle 150% I_{2hd} for 1 minute / 5 minutes allowed.

- Current ratings do not change with different supply voltages.

- The rated current of the ACS800 must be greater than or equal to the rated motor current to achieve the rated motor power given in the table.

- Horsepower ratings are based on NEMA motor ratings for typical 4-pole motors (1800 rpm). Check motor nameplate current for compatibility.

Enclosure

Degree of Protection:
UL Type 1 (Standard)
UL Type 1 Filtered, UL Type 12 (opt)
Paint color:
Light beige RAL 7035 semi-gloss



Ultra low harmonic, wall mounted

ACS800-U31, 7.5 to 125 Hp

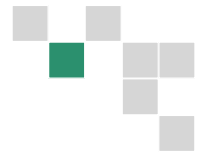

Simple low harmonic solution

There is increasing concern among end users and power companies about the harmful effects of harmonics. Harmonic distortion may disturb or even damage sensitive equipment connected in the same environment. Harmonic standards are thus becoming stricter and there is a growing demand for low harmonic solutions.

The ACS800-U31 drive offers an easy solution to the problem of harmonics. The solution itself is incorporated in the drive, eliminating the need for any additional filtering equipment or complicated and large multi-pulse transformer arrangements.

Meets the strictest standards

The ACS800-U31 eliminates low order harmonics with the active converter controlled with DTC, and high order harmonics with an LCL line filter. The result is exceptionally low harmonic content in the network; exceeding the requirements set by standard IEEE519 at the drive input terminals even on the weakest AC line network. The ACS800-U31 provides you with a simple, compact and complete solution to meet stringent power quality standards.

Beats external solutions

The ACS800-U31 does not require a dedicated multi-pulse transformer and thus is simpler in terms of cabling arrangements and requires less floor space. Harmonic performance is better than with 12- and 18-pulse solutions. Passive or active external filtering devices are avoided with the ACS800-U31, making the solution compact and simple. Other advantages of the ACS800-U31 is that it always operates with unity power factor 1 and is impervious to AC Line Voltage imbalances up to and over 3%. The system efficiency is also better than 12 and 18-pulse solutions due to the simplified transformer.

Main standard features

- Meets IEEE519-1992 at Drive input terminals
- Wall mounting
- Compact design
- UL Type 1 protection class
- Built in low harmonic LCL filter
- Coated boards
- Extensive, programmable I/O
- Long lifetime cooling fan and capacitors
- Inputs galvanically isolated
- 3 I/O and fieldbus extension slots inside
- Alphanumeric multilingual control panel with a start-up assistant feature

Options for ACS800-U31

- Braking chopper
- EMC filter for 1st environment, restricted distribution according to EN 61800-3
- EMC filter for 2nd environment, unrestricted distribution according to EN 61800-3
- Analog and digital I/O extension modules
- Fieldbus modules
- Pulse encoder interface module
- Resolver interface (limited SW Support)



Ratings and dimensions

ACS800-U31

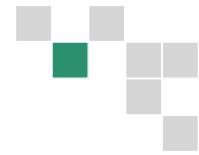

ACS800 - U31 - XXXX - 25 + XXXX

Type code	Frame size	Input A	I_{max} A	Normal Duty		Heavy-duty use		Noise Level dBA	Air flow ft ³ /min	Heat Dissipation BTU/hr
				I_{2N} A	P_N Hp	I_{2HD} A	P_{HD} Hp			
3-phase supply voltage 208, 220, 230, 240. The power ratings are valid at nominal voltage, 240Vac (50 & 60Hz)										
ACS800-U31-0011-2	R5	32	52	32	10	26	7.5	70	206	1730
ACS800-U31-0016-2	R5	44	68	45	15	38	10	70	206	2380
ACS800-U31-0020-2	R5	55	90	56	20	45	10	70	206	3110
ACS800-U31-0025-2	R5	70	118	69	25	59	15	70	206	3760
ACS800-U31-0030-2	R5	82	144	83	30	72	20	70	206	4500
ACS800-U31-0040-2	R6	112	168	114	40	84	25	73	238	5420
ACS800-U31-0050-2	R6	140	234	143	50	117	30	73	238	7260
ACS800-U31-0060-2	R6	157	264	157	60	132	40	73	238	8650
3-phase supply voltage 380, 400, 415, 460, 480, 500. The power ratings are valid at nominal voltage, 480Vac 60Hz										
ACS800-U31-0020-5	R5	29	52	29	20	25	15	70	206	2240
ACS800-U31-0025-5	R5	33	61	34	25	30	20	70	206	2600
ACS800-U31-0030-5	R5	44	68	45	30	37	25	70	206	3420
ACS800-U31-0040-5	R5	54	90	55	40	47	30	70	206	4140
ACS800-U31-0050-5	R5	65	118	67	50	57	40	70	206	4960
ACS800-U31-0060-5	R5	76	144	78	60	62	50	70	206	5980
ACS800-U31-0070-5	R6	112	168	114	75	88	60	73	238	8030
ACS800-U31-0100-5	R6	129	234	132	100	114	75	73	238	9570
ACS800-U31-0120-5	R6	145	264	156	125	125	100	73	238	11620
3-phase supply voltage 525, 575, 600. The power ratings are valid at nominal voltage, 575Vac 60Hz										
ACS800-U31-0060-7	R6	53	62	54	50	43	40	73	238	5980
ACS800-U31-0070-7	R6	73	79	75	60	60	50	73	238	8030
ACS800-U11-0100-7	R6	86	99	88	75	71	60	73	238	9570

Frame size	UL Type 1			
	Height (in)	Width (in)	Depth (in)	Weight (lbs)
R5	32.1	10.4	15.4	143
R6	38.2	11.8	17.3	220.5

Enclosure
 Degree of Protection:
 UL Type 1(Standard)
 Paint color:
 NCS 1502-Y (RAL 90021/PMS 420C)

NOTES:

- I_{max} current available for 10 seconds at start.
- I_{2N} continuous base current at 40°C (104°F). Overload cycle 110% I_{2N} for 1 minute / 5 minutes allowed.
- I_{2HD} continuous base current at 40°C (104°F). Overload cycle 150% I_{2HD} for 1 minute / 5 minutes allowed.
- Current ratings do not change with different supply voltages.
- Horsepower ratings are based on NEMA motor ratings for typical 4-pole motors (1800 rpm). Check motor nameplate current for compatibility.

Alternatives in reducing AC line harmonics

6 pulse rectifier	12 pulse rectifier	18 pulse rectifier	ACS800-U31
Transformer and cabling simple	Transformer and cabling complicated	Transformer and cabling complicated	Transformer and cabling simple
Current very distorted >I _{thd} 30%	Current distorted >I _{thd} 12%	Current wave form good >I _{thd} 6%	Current wave form best I _{thd} ~ 4.5%
I _{thd} = Total Harmonic Distortion Current			

Ultra low harmonic drive, cabinet-built

ACS800-37, 125 to 2800 Hp

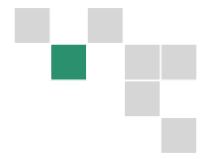

Simple low harmonic solution

There is increasing concern among end users and power companies about the harmful effects of harmonics. Harmonic distortion may disturb or even damage sensitive equipment connected in the same environment. Harmonic standards are thus becoming stricter and there is a growing demand for low harmonic solutions.

The ACS800-37 drive offers an easy solution to the problem of harmonics. The solution itself is incorporated in the drive, eliminating the need for any additional filtering equipment or complicated and large multi-pulse transformer arrangements.

Meets the strictest standards

The ACS800-37 eliminates low order harmonics with the active converter controlled with DTC, and high order harmonics with an LCL line filter. The result is exceptionally low harmonic content in the network; exceeding the requirements set by standard IEEE519 at the drive input terminals even on the weakest AC line network. The ACS800-37 provides you with a simple, compact, and complete solution to meet stringent power quality standards.

Beats external solutions

The ACS800-37 does not require a dedicated multi-pulse transformer and thus is simpler in terms of cabling arrangements and requires less floor space. Harmonic performance is better than both 12- and 18-pulse solutions. Passive or active external filtering devices are avoided with the ACS800-37, making the solution compact and simple. Other advantages of the ACS800-37 is that it always operates with unity power factor 1 and is impervious to AC line voltage imbalances up to and over 3%. The system efficiency is also better than 12 and 18-pulse solutions due to the simplified transformer.

Extensive range of features

In line with other ACS800 cabinet-built drives, the ACS800-37 offers a wide variety of standardized configurations to adapt to different application requirements. The smart module concept enables easy maintenance and redundancy in the high power range where multiple identical power modules make one power structure. If one power module fails the drive may be operated at reduced capacity.

Main standard features

- Meets IEEE519-1992 at Drive input terminals
- Compact design
- UL Type 1 protection class
- Built in low harmonic LCL filter
- EMC filter for 2nd environment, unrestricted distribution according to EN 61800-3
- Main switch with aR fuses
- Line contactor
- Removable air circuit breaker (in frame size nxR8i)
- Du/dt filters (in frame size nxR8i)
- Coated boards
- Extensive, programmable I/O
- Long lifetime cooling fan and capacitors
- Inputs galvanically isolated
- 3 I/O and fieldbus extension slots inside
- Alphanumeric multilingual control panel with a start-up assistant feature

Options for ACS800-37

- Analogue and digital I/O extension modules
- Braking chopper and resistor
- Cabinet heater
- Customer terminal block
- Du/dt filters (in frame sizes R7i-R8i)
- Earth fault monitoring for unearthed network
- EMC filter for 1st environment, restricted distribution according to EN 61800-3
- Fieldbus modules
- UL Type 1 Filtered or UL Type 12 enclosure classes
- Emergency stop, category 0 or 1
- Output for motor fan
- Pulse encoder interface module
- Prevention of unexpected start up of motor
- Bottom entry and exit of cables
- 1 or 2 thermistor relays
- 3, 5 or 8 PT100 relays

Plus tailor made accessories through ABB's application engineering.

Ratings and dimensions

ACS800-37

ACS800 - 37 - XXXX - 57 + XXXX

Type code	Frame size	Input A	I _{max} A	Normal Duty		Heavy-duty use		Noise Level dBA	Air flow ft ³ /min	Heat Dissipation BTU/Hr
				I _{2N} A	P _N Hp	I _{2HD} A	P _{HD} Hp			
3-phase supply voltage 380, 400, 415, 460, 480, 500. The power ratings are valid at nominal voltage, 480Vac 60Hz										
ACS800-37-0070-5+C129	R6	112	168	114	75	88	60	73	295	8200
ACS800-37-0100-5+C129	R6	129	234	132	100	114	75	73	295	9600
ACS800-37-0120-5+C129	R6	145	264	156	125	125	100	73	295	11600
ACS800-37-0170-5+C129	R7i	180	291	192	150	156	125	74	765	20500
ACS800-37-0210-5+C129	R7i	220	355	240	200	183	150	74	765	27300
ACS800-37-0260-5+C129	R8i	270	438	302	250	226	150	75	1860	30700
ACS800-37-0320-5+C129	R8i	329	530	361	300	273	200	75	1860	37600
ACS800-37-0400-5+C129	R8i	410	660	437	350	340	250	75	1860	47800
ACS800-37-0460-5+C129	R8i	473	762	504	400	393	300	75	1860	54700
ACS800-37-0510-5+C129	R8i	536	863	571	450	445	350	75	1860	61500
ACS800-37-0610-5+C129	R8i	630	1016	672	550	524	400	75	1860	78600
ACS800-37-0780-5+C129+H359	2xR8i	803	1294	856	700	667	550	77	3770	88800
ACS800-37-0870-5+C129+H359	2xR8i	900	1458	965	800	752	650	77	3770	109000
ACS800-37-1160-5+C129+H359	2xR8i	1200	1941	1284	1050	1001	850	77	3770	150000
ACS800-37-1330-5+C129+H359	3xR8i	1376	2217	1467	1250	1143	1000	78	6030	157000
ACS800-37-1820-5+C129+H359	3xR8i	1888	2956	1956	1650	1524	1300	78	6030	229000
ACS800-37-2200-5+C129+H359	4xR8i	2344	3670	2428	2050	1892	1600	79	7530	277000
3-phase supply voltage 525, 550, 575, 600, 690. The power ratings are valid at nominal voltage, 575Vac 60Hz										
ACS800-37-0060-7+C129	R6	53	86	54	50	43	40	73	294	6142
ACS800-37-0070-7+C129	R6	73	120	75	60	60	50	73	294	8190
ACS800-37-0100-7+C129	R6	86	142	88	75	71	60	73	294	9554
ACS800-37-0170-7+C129	R7i	125	202	133	125	104	100	74	765	27300
ACS800-37-0210-7+C129	R7i	146	235	156	150	121	100	74	765	30700
ACS800-37-0260-7+C129	R8i	180	301	193	200	150	150	75	1860	41000
ACS800-37-0320-7+C129	R8i	250	417	268	250	209	200	75	1860	51200
ACS800-37-0400-7+C129	R8i	300	502	322	300	251	250	75	1860	61500
ACS800-37-0440-7+C129	R8i	344	571	367	350	286	300	75	1860	64900
ACS800-37-0540-7+C129	R8i	400	668	429	450	334	350	75	1860	71700
ACS800-37-0790-7+C129+H359	2xR8i	593	985	632	650	493	500	77	3770	120000
ACS800-37-0870-7+C129+H359	2xR8i	657	1091	700	750	545	600	77	3770	126000
ACS800-37-1160-7+C129+H359	2xR8i	853	1425	914	1000	713	750	77	3770	157000
ACS800-37-1330-7+C129+H359	3xR8i	1001	1663	1067	1150	831	900	78	6030	185000
ACS800-37-1510-7+C129+H359	3xR8i	1164	1879	1206	1300	940	1050	78	6030	212000
ACS800-37-2320-7+C129+H359	4xR8i	1729	2791	1791	2000	1396	1500	79	7530	304000
ACS800-37-2780-7+C129+H359	5xR8i	2091	3472	2228	2450	1736	1900	79	10550	362000
ACS800-37-3310-7+C129+H359	6xR8i	2470	3987	2559	2800	1999	2200	79	11300	413000

Frame size	Width in	Height UL Type 1 in	Height UL Type 12 in	Depth top entry/exit ^{B)} in	Weight lb
R6	16.9	83.9	91.1	25.4	550
R7i	24.8	83.9	91.1	25.4	880
R8i	48.4 ^{A)}	83.9	91.1	25.4	2090
2xR8i	107.5	83.9	91.1	25.4	4982
3xR8i	139.0	83.9	91.1	25.4	6746
4xR8i	178.3	83.9	91.1	25.4	7937
5xR8i	225.6	83.9	91.1	25.4	10538
6xR8i	243.4	83.9	91.1	25.4	10869

^{A)} 60.2 in if equipped with 1st environment filter and common motor terminal.
^{B)} The depth without the handle.

NOTES:

I_{max} current available for 10 seconds at start.
 I_{2N} continuous base current at 40°C (104°F).
 Overload cycle 110% I_{2N} for 1 minute / 5 minutes allowed.
 I_{2HD} continuous base current at 40°C (104°F).
 Overload cycle 150% I_{2HD} for 1 minute / 5 minutes allowed.

- Current ratings do not change with different supply voltages.
 - The rated current of the ACS800 must be greater than or equal to the rated motor current to achieve the rated motor power given in the table.
 - Horsepower ratings are based on NEMA motor ratings for typical 4-pole motors (1800 rpm). Check motor nameplate current for compatibility.

Enclosure

Degree of Protection:
 UL Type 1 (Standard)
 UL Type 1 Filtered and UL Type 12 (opt)
 Paint color:
 Light beige RAL 7035 semi-gloss

Alternatives in reducing AC line harmonics

6 pulse rectifier	12 pulse rectifier	18 pulse rectifier	ACS800-37
Transformer and cabling simple	Transformer and cabling complicated	Transformer and cabling complicated	Transformer and cabling simple
Current very distorted >I _{thd} 30%	Current distorted >I _{thd} 12%	Current wave form good >I _{thd} 6%	Current wave form best I _{thd} ~ 4.5%

I_{thd} = Total Harmonic Distortion Current

Brake options

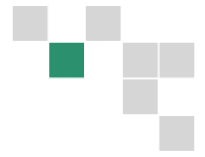

Brake chopper

The ACS800 series has built in brake choppers for all types. Therefore, no additional space or installation time is needed. The brake chopper is part of the standard delivery for the frame sizes R2 - R3 and at 690V frame R4. For the other frames a brake chopper is a selectable option.

Braking control is integrated into the ACS800 series. It controls the braking, supervises the system status and detects failures such as brake resistor and resistor cable short circuits, chopper short circuit, and calculated resistor overtemperature.

Brake resistor

Brake resistors are separately available for all ACS800 types. Resistors other than the standard resistors may be used providing the specified resistance value is not decreased, and the heat dissipation capacity of the resistor is sufficient for the drive application.

For ACS800 units, no separate fuses in the brake circuit are required if the following conditions are met:

- The ACS800 mains cable is protected with fuses
- No mains cable/fuse overrating takes place

Dynamic Braking Table - 200-240V applications, stopping duty only

Drive P/N ACS800-U1-	HP ND	Duty Cycle = 3sec on / 27sec off				Duty Cycle = 10sec on / 50sec off			
		Resistor Part No.	Ohms	Watts	Dimensions	Resistor Part No.	Ohms	Watts	Dimensions
0001-2	1	ABB-48431-020	44.0	324	12Wx5Dx5H	ABB-48431-020	44.0	324	12Wx5Dx5H
0002-2	1.5	ABB-48431-020	44.0	324	12Wx5Dx5H	ABB-48431-020	44.0	324	12Wx5Dx5H
0003-2	2	ABB-48431-020	44.0	324	12Wx5Dx5H	ABB-48431-020	44.0	324	12Wx5Dx5H
0004-2	3	ABB-48431-020	44.0	324	12Wx5Dx5H	ABB-48431-021	44.0	800	12Wx7Dx5H
0006-2	5	ABB-48431-001	22.0	285	12Wx5Dx5H	ABB-48431-002	22.0	819	12Wx7Dx5H
0009-2	7.5	ABB-48431-002	22.0	819	12Wx7Dx5H	ABB-48431-002	22.0	819	12Wx7Dx5H
0011-2	10	ABB-48431-030	13.0	1433	12Wx13Dx5H	ABB-48431-030	13.0	1433	12Wx13Dx5H
0016-2	15	ABB-48431-091	8.5	719	12Wx7Dx5H	ABB-48431-093	8.5	1224	12Wx10Dx5H
0020-2	20	ABB-41133	8.0	900	12Wx10Dx5H	ABB-48431-096	8.5	2754	19Wx10Dx5H
0025-2	25	ABB-41148	6.0	3000	19Wx10Dx5H	ABB-41148	6.0	3000	19Wx10Dx5H
0030-2	30	ABB-48431-181	4.3	3135	19Wx10Dx5H	ABB-48431-181	4.3	3135	19Wx10Dx5H
0040-2	40	ABB-48431-181	4.3	3135	19Wx10Dx5H	ABB-41149	4.0	3600	19Wx10Dx5H
0050-2	50	ABB-48431-301	2.5	2723	19Wx10Dx5H	ABB-48431-304	2.5	6250	26.5Wx13Dx5H
0060-2	60	ABB-49173-006	2.0	3600	19Wx10Dx5H	ABB-49173-007	2.0	8600	26.5Wx16Dx5H
0070-2	75	ABB-49173-006	2.0	3600	19Wx10Dx5H	ABB-49173-007	2.0	8600	26.5Wx16Dx5H

Drive P/N ACS800-U1-	HP ND	Duty Cycle = 30sec on / 180sec off				Duty Cycle = 60sec on / 180sec off			
		Resistor Part No.	Ohms	Watts	Dimensions	Resistor Part No.	Ohms	Watts	Dimensions
0001-2	1	ABB-48431-020	44.0	324	12Wx5Dx5H	ABB-48431-020	44.0	324	12Wx5Dx5H
0002-2	1.5	ABB-48431-020	44.0	324	12Wx5Dx5H	ABB-48431-020	44.0	324	12Wx5Dx5H
0003-2	2	ABB-48431-021	44.0	800	12Wx7Dx5H	ABB-48431-021	44.0	800	12Wx7Dx5H
0004-2	3	ABB-48431-021	44.0	800	12Wx7Dx5H	ABB-48431-021	44.0	800	12Wx7Dx5H
0006-2	5	ABB-48431-002	22.0	819	12Wx7Dx5H	ABB-48431-003	22.0	1140	12Wx10Dx5H
0009-2	7.5	ABB-48431-003	22.0	1140	12Wx10Dx5H	ABB-48431-005	22.0	1862	12Wx16Dx5H
0011-2	10	ABB-48431-030	13.0	1433	12Wx13Dx5H	ABB-44473	13.5	2509	19Wx10Dx5H
0016-2	15	ABB-48431-095	8.5	1913	12Wx16Dx5H	ABB-41170	8.0	4600	26.5Wx10Dx5H
0020-2	20	ABB-48431-096	8.5	2754	19Wx10Dx5H	ABB-41170	8.0	4600	26.5Wx10Dx5H
0025-2	25	ABB-41160	6.0	3800	19Wx10Dx5H	ABB-41162	6.0	5200	26.5Wx10Dx5H
0030-2	30	ABB-41149	4.0	3600	19Wx10Dx5H	ABB-44479	4.3	9872	26.5Wx16Dx5H
0040-2	40	ABB-41150	4.0	5600	26.5Wx10Dx5H	ABB-44479	4.3	9872	26.5Wx16Dx5H
0050-2	50	ABB-48431-304	2.5	6250	26.5Wx13Dx5H	ABB-48431-305	2.5	16000	28Wx16Dx10H
0060-2	60	ABB-49173-007	2.0	8600	26.5Wx16Dx5H	ABB-48431-330	2.2	14080	28Wx16Dx10H
0070-2	75	ABB-48431-330	2.2	14080	28Wx16Dx10H	ABB-42684	2.3	18000	28Wx16Dx10H

Brake options

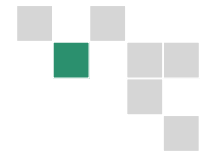

Dynamic Braking Table - 380-480V applications, stopping duty only

Drive P/N ACS800-U1-	HP ND	Duty Cycle = 3sec on / 27sec off				Duty Cycle = 10sec on / 50sec off			
		Resistor Part No.	Ohms	Watts	Dimensions	Resistor Part No.	Ohms	Watts	Dimensions
0004-5	3	ABB-48431-020	44.0	324	12Wx5Dx5H	ABB-48431-020	44.0	324	12Wx5Dx5H
0005-5	3	ABB-48431-020	44.0	324	12Wx5Dx5H	ABB-48431-020	44.0	324	12Wx5Dx5H
0006-5	5	ABB-48431-020	44.0	324	12Wx5Dx5H	ABB-48431-021	44.0	800	12Wx7Dx5H
0009-5	8	ABB-48431-021	44.0	800	12Wx7Dx5H	ABB-48431-021	44.0	800	12Wx7Dx5H
0011-5	10	ABB-48431-021	44.0	800	12Wx7Dx5H	ABB-48431-022	44.0	1263	12Wx10Dx5H
0016-5	15	ABB-48431-002	22.0	819	12Wx7Dx5H	ABB-48431-004	22.0	1408	12Wx13Dx5H
0020-5	20	ABB-48431-003	22.0	1140	12Wx10Dx5H	ABB-48431-006	22.0	2200	19Wx10Dx5H
0025-5	25	ABB-48431-004	22.0	1408	12Wx13Dx5H	ABB-48431-007	22.0	2426	19Wx10Dx5H
0030-5	30	ABB-48431-031	13.0	1872	12Wx16Dx5H	ABB-48431-033	13.0	3328	19Wx10Dx5H
0040-5	40	ABB-48431-032	13.0	2197	19Wx10Dx5H	ABB-48431-035	13.0	4212	26.5Wx10Dx5H
0050-5	50	ABB-48431-096	8.5	2754	19Wx10Dx5H	ABB-48431-068	11.0	4400	26.5Wx10Dx5H
0060-5	60	ABB-48431-097	8.5	5313	26.5Wx13Dx5H	ABB-48431-097	8.5	5313	26.5Wx13Dx5H
0070-5	75	ABB-48431-120	8.0	6272	26.5Wx16Dx5H	ABB-48431-099	8.5	7650	26.5Wx16Dx5H
0100-5	100	ABB-48431-159	5.3	4770	26.5Wx10Dx5H	ABB-48431-184	4.3	10750	28Wx10Dx10H
0120-5	125	ABB-48431-183	4.3	6209	26.5Wx13Dx5H	ABB-48431-185	4.3	17067	28Wx13Dx10H
0140-5	150	ABB-48431-184	4.3	10750	28Wx10Dx10H	ABB-48431-185	4.3	17067	28Wx13Dx10H
0205-5	200	ABB-48431-184	4.3	10750	28Wx10Dx10H	ABB-48431-185	4.3	17067	28Wx13Dx10H

Drive P/N ACS800-U1-	HP ND	Duty Cycle = 30sec on / 180sec off				Duty Cycle = 60sec on / 180sec off			
		Resistor Part No.	Ohms	Watts	Dimensions	Resistor Part No.	Ohms	Watts	Dimensions
0004-5	3	ABB-48431-020	44.0	324	12Wx5Dx5H	ABB-48431-021	44.0	800	12Wx7Dx5H
0005-5	3	ABB-48431-021	44.0	800	12Wx7Dx5H	ABB-48431-021	44.0	800	12Wx7Dx5H
0006-5	5	ABB-48431-021	44.0	800	12Wx7Dx5H	ABB-48431-022	44.0	1263	12Wx10Dx5H
0009-5	8	ABB-48431-022	44.0	1263	12Wx10Dx5H	ABB-48431-023	44.0	3294	19Wx13Dx5H
0011-5	10	ABB-48431-023	44.0	3294	19Wx13Dx5H	ABB-48431-023	44.0	3294	19Wx13Dx5H
0016-5	15	ABB-48431-006	22.0	2200	19Wx10Dx5H	ABB-48431-009	22.0	5632	26.5Wx10Dx5H
0020-5	20	ABB-48431-008	22.0	3168	19Wx13Dx5H	ABB-48431-009	22.0	5632	26.5Wx10Dx5H
0025-5	25	ABB-48431-008	22.0	3168	19Wx13Dx5H	ABB-48431-009	22.0	5632	26.5Wx10Dx5H
0030-5	30	ABB-48431-035	13.0	4212	26.5Wx10Dx5H	ABB-48431-037	13.0	8125	26.5Wx16Dx5H
0040-5	40	ABB-48431-036	13.0	6292	26.5Wx13Dx5H	ABB-48431-038	13.0	11700	28Wx13Dx10H
0050-5	50	ABB-48431-069	11.0	6875	26.5Wx13Dx5H	ABB-48431-100	8.5	12274	28Wx13Dx10H
0060-5	60	ABB-48431-100	8.5	12274	28Wx13Dx10H	ABB-48431-101	8.5	16456	28Wx16Dx10H
0070-5	75	ABB-48431-100	8.5	12274	28Wx13Dx10H	ABB-48431-101	8.5	16456	28Wx16Dx10H
0100-5	100	ABB-48431-162	5.3	13250	28Wx13Dx10H	ABB-48431-211	4.0	22500	28Wx16Dx10H
0120-5	125	ABB-48431-185	4.3	17067	28Wx13Dx10H	ABB-48431-187	4.3	27520	30Wx18Dx24H
0140-5	150	ABB-48431-211	4.0	22500	28Wx16Dx10H	ABB-48431-188	4.3	34830	30Wx18Dx24H
0205-5	200	ABB-48431-212	4.0	25610	30Wx18Dx24H	ABB-48431-189	4.3	43000	30Wx18Dx24H

Brake options

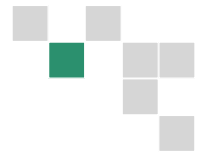

Dynamic Braking Table - 380-480V applications, stopping duty only

Drive P/N ACS800-PC/U2/U7-	HP ND	Duty Cycle = 3sec on / 27sec off				Duty Cycle = 10sec on / 50sec off			
		Resistor Part No.	Ohms	Watts	Dimensions	Resistor Part No.	Ohms	Watts	Dimensions
0170-5	150	ABB-48431-271	2.9	14210	28Wx10Dx10H	ABB-48431-272	2.9	16313	28Wx10Dx10H
0210-5	200	ABB-48431-271	2.9	14210	28Wx10Dx10H	ABB-48431-273	2.9	23490	28Wx16Dx10H
0260-5	200	ABB-48431-271	2.9	14210	28Wx10Dx10H	ABB-48431-273	2.9	23490	28Wx16Dx10H
0270-5	250	ABB-48431-271	2.9	14210	28Wx10Dx10H	ABB-48431-273	2.9	23490	28Wx16Dx10H
0300-5	300	ABB-48431-331	2.2	17820	28Wx13Dx10H	ABB-48431-332	2.2	26620	30Wx18Dx24H
0320-5	350	ABB-48431-331	2.2	17820	28Wx13Dx10H	ABB-48431-332	2.2	26620	30Wx18Dx24H
0400-5	400	ABB-48431-393	1.7	24480	30Wx18Dx16H	ABB-48431-395	1.7	46283	30Wx18Dx32H
0440-5	450	ABB-48431-480	1.2	32670	30Wx18Dx24H	ABB-48431-482	1.2	60750	30Wx18Dx32H
0490-5	500	ABB-48431-514	1.0	34200	30Wx18Dx24H	ABB-48431-517	1.0	67600	30Wx18Dx40H
0550-5	550	ABB-48431-514	1.0	34200	30Wx18Dx24H	ABB-48431-517	1.0	67600	30Wx18Dx40H
0610-5	600	ABB-48431-515	1.0	40000	30Wx18Dx24H	ABB-48431-518	1.0	90000	30Wx18Dx48H

Drive P/N ACS800-PC/U2/U7-	HP ND	Duty Cycle = 30sec on / 180sec off				Duty Cycle = 60sec on / 180sec off			
		Resistor Part No.	Ohms	Watts	Dimensions	Resistor Part No.	Ohms	Watts	Dimensions
0170-5	150	ABB-48431-273	2.9	23490	28Wx16Dx10H	ABB-48431-275	2.9	41760	30Wx18Dx32H
0210-5	200	ABB-48431-274	2.9	29000	30Wx18Dx16H	ABB-48431-276	2.9	52853	30Wx18Dx32H
0260-5	200	ABB-48431-274	2.9	29000	30Wx18Dx16H	ABB-48431-276	2.9	52853	30Wx18Dx32H
0270-5	250	ABB-48431-274	2.9	29000	30Wx18Dx16H	ABB-48431-276	2.9	52853	30Wx18Dx32H
0300-5	300	ABB-48431-334	2.2	40095	30Wx18Dx32H	ABB-48431-366	1.8	72000	30Wx18Dx48H
0320-5	350	ABB-48431-334	2.2	40095	30Wx18Dx32H	ABB-48431-366	1.8	72000	30Wx18Dx48H
0400-5	400	ABB-48431-396	1.7	58183	30Wx18Dx32H	ABB-48431-544*	0.9	45600	30Wx18Dx24H
0440-5	450	ABB-48431-484	1.2	81120	30Wx18Dx48H	ABB-48431-573*	0.6	73500	30Wx18Dx48H
0490-5	500	ABB-48431-518	1.0	90000	30Wx18Dx48H	ABB-Consult Factory			
0550-5	550	ABB-48431-518	1.0	90000	30Wx18Dx48H	ABB-Consult Factory			
0610-5	600	ABB-48431-518	1.0	90000	30Wx18Dx48H	ABB-Consult Factory			

* Requires two resistor assemblies each rated as show and connected in series. (Order quantity 2)

Brake options

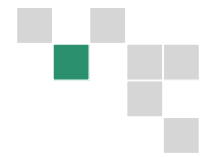

Brake chopper and resistor options for ACS800-07 in frame sizes 2xR8i and 3xR8i.

Type	Nominal ratings					Duty cycle		Duty cycle		E _r kJ	Brake chopper type	Resistor type	Additional width mm
	P _{br. max} kW	R ohm	I _{max} A	I _{rms} A	P _{cont.} kW	P _{br.} kW	I _{rms} A	P _{br.} kW	I _{rms} A				
U_N = 500 V													
ACS800-07-0760-5+D150	806	2x1.43	1142	272	218	634	782	806	996	-	2xNBRA659	-	800
ACS800-07-0910-5+D150	806	2x1.43	1142	272	218	634	782	806	996	-	2xNBRA659	-	800
ACS800-07-1090-5+D150	1208	3x1.43	1713	408	327	951	1173	1209	1494	-	3xNBRA659	-	1200
ACS800-07-1210-5+D150	1208	3x1.43	1713	408	327	951	1173	1209	1494	-	3xNBRA659	-	1200
ACS800-07-0760-5+D150+D151	806	2x1.35	1210	134	108	333	412	575	710	21600	2xNBRA659	2x(2xSAFUR200F500)	2400
ACS800-07-0910-5+D150+D151	806	2x1.35	1210	134	108	333	412	575	710	21600	2xNBRA659	2x(2xSAFUR200F500)	2400
ACS800-07-1090-5+D150+D151	1208	3x1.35	1815	201	162	500	618	862	1065	32400	3xNBRA659	3x(2xSAFUR200F500)	3600
ACS800-07-1210-5+D150+D151	1208	3x1.35	1815	201	162	500	618	862	1065	32400	3xNBRA659	3x(2xSAFUR200F500)	3600
U_N = 690 V													
ACS800-07-0750-7+D150	807	2x2.72	828	214	238	596	534	808	722	-	2xNBRA669	-	800
ACS800-07-0870-7+D150	807	2x2.72	828	214	238	596	534	808	722	-	2xNBRA669	-	800
ACS800-07-1060-7+D150	1211	3x2.72	1242	321	357	894	801	1212	1083	-	3xNBRA669	-	1200
ACS800-07-1160-7+D150	1211	3x2.72	1242	321	357	894	801	1212	1083	-	3xNBRA669	-	1200
ACS800-07-0750-7+D150+D151	807	2x1.35	1670	194	108	333	298	575	514	21600	2xNBRA669	2x(2xSAFUR200F500)	2400
ACS800-07-0870-7+D150+D151	807	2x1.35	1670	194	108	333	298	575	514	21600	2xNBRA669	2x(2xSAFUR200F500)	2400
ACS800-07-1060-7+D150+D151	1211	3x1.35	2505	291	162	500	447	862	771	32400	3xNBRA669	3x(2xSAFUR200F500)	3600
ACS800-07-1160-7+D150+D151	1211	3x1.35	2505	291	162	500	447	862	771	32400	3xNBRA669	3x(2xSAFUR200F500)	3600

Note: SAFUR resistors available as open chasis (IP00). Not available with UL. As an enclosed offering only offered NEMA 1 in drive line up (800-07, 800-37)

Brake chopper and resistor options for ACS800-37 in frame sizes R6-2xR8i.

Type	Nominal ratings					Duty cycle		Duty cycle		E _r kJ	Brake chopper type	Resistor type	Additional width mm
	P _{br. max} kW	R ohm	I _{max} A	I _{rms} A	P _{cont.} kW	P _{br.} kW	I _{rms} A	P _{br.} kW	I _{rms} A				
U_N = 500 V													
ACS800-37-0170...0210-5+D150	268	2.15	380	101	81	268	331	268	331	-	NBRA658	-	400
ACS800-37-0260...0610-5+D150	403	1.43	571	135	109	317	391	403	498	-	NBRA659	-	400
ACS800-37-0780...0870-5+D150	806	2x1.43	1142	272	218	634	782	806	996	-	2xNBRA659	-	800
ACS800-37-1160-5+D150	1208	3x1.43	1713	408	327	951	1173	1209	1494	-	3xNBRA659	-	1200
ACS800-37-0070...0210-5+D150+D151	268	2	408	45	36	111	137	192	237	7200	NBRA658	2xSAFUR125F500	1200
ACS800-37-0260...0610-5+D150+D151	403	1.35	605	67	54	167	206	287	355	10800	NBRA659	2xSAFUR200F500	1200
ACS800-37-0780...0870-5+D150+D151	806	2x1.35	1210	134	108	333	412	575	710	21600	2xNBRA659	2x(2xSAFUR200F500)	2400
ACS800-37-1160+D150+D151	1208	3x1.35	1815	201	162	500	618	862	1065	32400	3xNBRA659	3x(2xSAFUR200F500)	3600
U_N = 690 V													
ACS800-37-0170...0540-7+D150	404	2.72	414	107	119	298	267	404	361	-	NBRA669	-	400
ACS800-37-0790...0870-7+D150	807	2x2.72	828	214	238	596	534	808	722	-	2xNBRA669	-	800
ACS800-37-1160-7+D150	1211	3x2.72	1242	321	357	894	801	1212	1083	-	3xNBRA669	-	1200
ACS800-37-0170...0540-7+D150+D151	404	1.35	835	97	54	167	149	287	257	10800	NBRA669	2xSAFUR200F500	1200
ACS800-37-0790...0870-7+D150+D151	807	2x1.35	1670	194	108	333	298	575	514	21600	2xNBRA669	2x(2xSAFUR200F500)	2400
ACS800-37-1160-7+D150+D151	1211	3x1.35	2505	291	162	500	447	862	771	32400	3xNBRA669	3x(2xSAFUR200F500)	3600

Brake choppers and resistors for larger types are available as customised option.

The drive may limit the available braking power.

- P_{br. max} = Maximum short time braking power.
- R = Recommended braking resistor resistance.
Also nominal resistance of corresponding SAFUR resistor.
- I_{max} = Maximum peak current during braking.

Current is achieved with recommended resistor resistance.

- P_{cont.} = Maximum continuous braking power.
- E_r = SAFUR resistor nominal braking capacity without forced cooling.
- P_{br.} = Braking power during corresponding cycle load:
1 min / 5 min = 1 minute braking with power P_{br.} and 4 minutes unload.
10 s / 60 s = 10 second braking with power P_{br.} and 50 seconds unload.
- I_{rms} = Corresponding rms current per chopper during load cycle.

EMC filter options

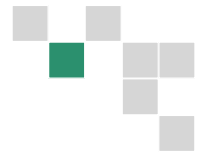

1st environment vs 2nd environment

1st environment

1st environment includes domestic premises. It also includes establishments directly connected without intermediate transformer to a low-voltage power supply network which supplies buildings used for domestic purposes.”

2nd environment

2nd environment includes all establishments other than those directly connected to a low-voltage power supply network which supplies buildings used for domestic purposes.”

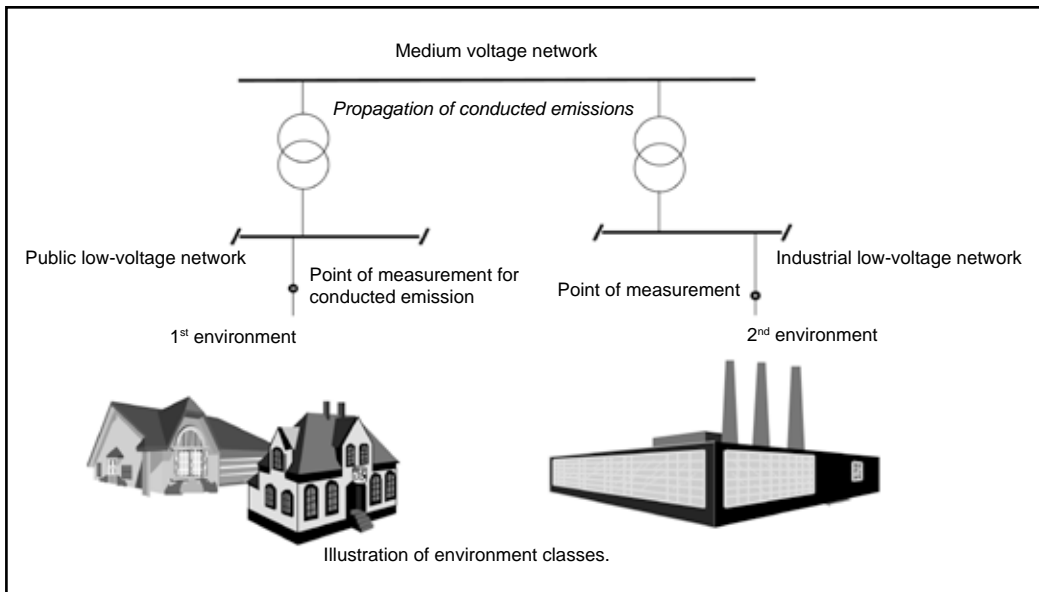

Declaration of conformity

All declarations concerning CE marking can be found on the www.abb.com/motors&drives website.

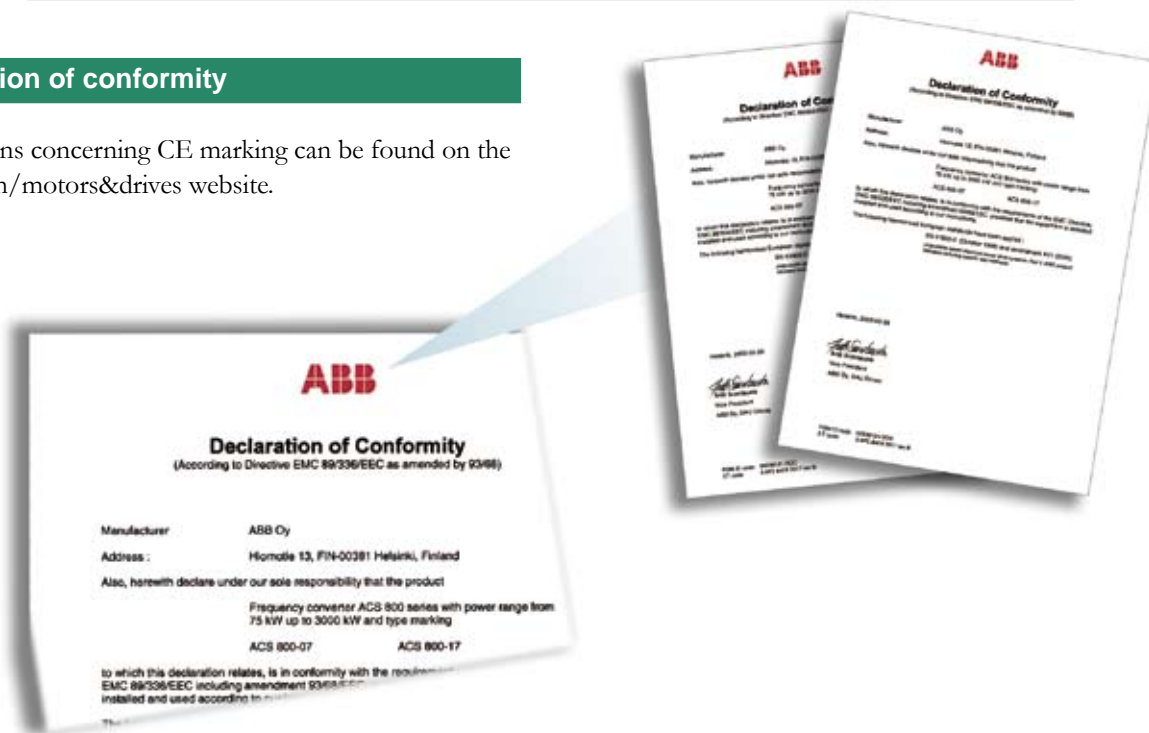

EMC filter options



EMC - Electromagnetic Compatibility and modules

The electrical/electronic equipment must be able to operate without problems within an electromagnetic environment. This is called immunity. The ACS800 is designed to have adequate immunity against interference from other equipment. Likewise, the equipment must not disturb or interfere with any other product or system within its locality. This is called emission. Each ACS800 model can be equipped with an inbuilt filter to reduce high frequency emission.

EMC standards

The EMC product standard [EN 61800-3 (1996) + Amendment A11 (2000)] covers the requirements stated for drives within the EU. The new revision of EN 61800-3 (2004) product standard can be applied from now on, but latest from 1 October 2007. In some cases other standards may be applicable. The emission limits are comparable according to the following table, EMC standards.

Selecting an EMC filter

The following table gives the correct filter selection.

EMC standards				
EN 61800/A11, (2000), product standard	EN 61800-3 (2004), product standard	EN 55011, product family standard for industrial, scientific and medical (ISM) equipment	EN 6100-6-4, generic emission standard for industrial environments	EN 61000-6-3, generic emission standard for residential, commercial and light-industrial environment
1 st environment, unrestricted distribution	Category C1	Group 1 Class B	Not applicable	Applicable
1 st environment, restricted distribution	Category C2	Group 1 Class A	Applicable	Not applicable
2 nd environment, unrestricted distribution	Category C3	Group 2 Class A	Not applicable	Not applicable
2 nd environment, restricted distribution	Category C4	Not applicable	Not applicable	Not applicable

Type	Voltage	Frame sizes	1 st environment, restricted distribution, grounded network (TN)	2 nd environment, grounded network (TN)	2 nd environment, floating network (IT)
800-U1	400-500	R1-R5	+E202	+E200	-
	400-500	R6	+E202	-	+E210
	690	R1-R5	-	+E200	-
	690	R6	-	-	+E210
800-U11	400-500	R5-R6	+E202	+E200	-
800-U2	400-500	R7-R8	+E202	+E210	+E210
	690	R7-R8	-	+E210	+E210
800-U7	400-500	R6	+E202	+E200	-
		R7-R8	+E202	+E210	+E210
800-07		nxR8i	+E202 (up to 1000A)	standard	standard
800-U7	690	R6	-	+E200	-
		R7-R8	-	+E210	+E210
800-07		nxR8i	-	standard	standard
800-17	400-500	R7i-nxR8i	+E202 (up to 1000A)	standard	standard
	690	R7i-nxR8i	-	standard	standard
800-37	400-500	R7i-nxR8i	+E202 (up to 1000A)	standard	standard
	690	R7i-nxR8i	-	standard	standard

du/dt output filter options

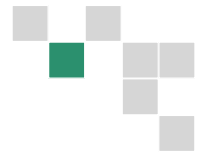

du/dt output filters and the ACS800

du/dt output filtering suppresses inverter output voltage spikes and rapid voltage changes that stress motor insulation. Additionally, du/dt filtering reduces capacitive leakage currents and high frequency emission of the motor cable as well as high frequency losses and bearing currents in the motor.

The need for du/dt filtering depends on the motor insulation. For information on the construction of the motor insulation, consult the motor manufacturer. If the motor

does not fulfill the following requirements, the lifetime of the motor might decrease.

Insulated N-end (non-driven end) bearings and/or common mode filters are also required for motor bearing currents with motors bigger than 100 kW. For more information please see the ACS800 hardware manuals.

Filter selection table for ACS800

Motor type	Nominal mains voltage (U_N)	Motor insulation requirement
ABB M2 and M3 motors	$U_N \leq 500 \text{ V}$	Standard insulation system.
	$500 \text{ V} < U_N \leq 600 \text{ V}$	Standard insulation system in conjunction with du/dt filtering or reinforced insulation.
	$600 \text{ V} < U_N \leq 690 \text{ V}$	Reinforced insulation system in conjunction with du/dt filtering.
ABB form-wound HXR and AM motors	$380 \text{ V} < U_N \leq 690 \text{ V}$	Standard insulation system.
ABB random-wound HXR and AM motors	$380 \text{ V} < U_N \leq 690 \text{ V}$	Check motor insulation system with the motor manufacturer. du/dt filtering with voltages over 500 V.
Non-ABB Random-wound and Form-wound	$U_N \leq 420 \text{ V}$	Insulation system must withstand $\hat{U}_{LL}=1300 \text{ V}$.
	$420 \text{ V} < U_N \leq 500 \text{ V}$	If the insulation system withstands $\hat{U}_{LL}=1600 \text{ V}$ and $\Delta t=0.2 \mu\text{s}$, du/dt filtering is not required. With du/dt filtering, the insulation system must withstand $\hat{U}_{LL}=1300 \text{ V}$.
	$500 \text{ V} < U_N \leq 600 \text{ V}$	If the insulation system withstands $\hat{U}_{LL}=1800 \text{ V}$, du/dt filtering is not required. With du/dt filtering, the insulation system must withstand $\hat{U}_{LL}=1600 \text{ V}$.
	$600 \text{ V} < U_N \leq 690 \text{ V}$	If the motor insulation system withstands $\hat{U}_{LL}=2000 \text{ V}$ and $\Delta t=0.3 \mu\text{s}$, du/dt filtering is not required. With du/dt filtering, the insulation system must withstand $\hat{U}_{LL}=1800 \text{ V}$.

Symbol	Explanation
U_N	Nominal AC Line voltage.
U_{LL}	Peak line to line voltage at motor terminals.
Δt	Rise time, i.e. interval during which line to line voltage at motor terminals changes from 10% to 90% of full voltage range.

du/dt output filter options

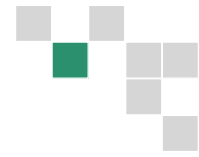

External du/dt output filters for ACS800-U1/-U2/-U11

ACS800		du/dt filter type (3 - 1 phase filters included in kits marked *)													
		Unprotected (IP 00)						Protected to IP 22			Protected to IP 54				
		NOCH0016-60	NOCH0030-60	*NOCH0070-60	*NOCH0120-60	*NOCH0260-60	*AOCH0260-70	*AOCH0400-70	NOCH0016-62	NOCH0030-62	NOCH0070-62	NOCH0120-62	NOCH0016-65	NOCH0030-65	NOCH0070-65
500 V	690 V														
-0004-5 -0005-5 -0006-5 -0009-5 -0011-5 -0016-5	-0011-7	1						1				1			
-0020-5	-0016-7 -0020-7 -0025-7	1						1					1		
-0025-5 -0030-5 -0040-5 -0050-5 -0060-5	-0030-7 -0040-7 -0050-7 -0060-7		1						1					1	
-0070-5 -0100-5 ^{*)}	-0070-7 -0100-7 -0120-7			1						1					1
U11-0100-5				1											
-0120-5				1											
-0140-5					1										
-0170-5 -0205-5 -0210-5	-0140-7 -0145-7 -0170-7 -0175-7					1									
-0260-5 -0270-5 -0300-5 -0320-5	-0205-7 -0210-7 -0260-7						1								
-0400-5	-0320-7 -0400-7						2								
-0440-5 -0490-5 -0550-5 -0610-5	-0440-7 -0490-7 -0550-7 -0610-7							2							

*) Note the exceptions for the ACS800-U11-0100-5.

Applicability

Factory-installed du/dt filters are available for the ACS800-07/-17/-37. They are installed inside the drive cabinet. The du/dt output filters are also separately available for other ACS800 types.

Separate filters need to be mounted separately. Unprotected IP 00 filters must be placed in an enclosure with an adequate degree of protection.

Dimensions and weights of the du/dt filters

du/dt filter	Height	Width	Depth	Weight
	in	in	in	lb
NOCH0016-60	7.68	5.51	4.53	5.29
NOCH0016-62/65	12.72	7.83	60.06	13.23
NOCH0030-60	8.46	6.50	5.12	10.36
NOCH0030-62/65	13.70	9.80	6.77	19.84
NOCH0070-60	10.28	7.09	5.91	20.94
NOCH0070-62/65	17.05	10.98	7.95	34.17
NOCH0120-60**	7.87	6.06	4.17	15.43
NOCH0120-62/65	30.12	12.13	10.08	99.21
NOCH0260-60**	15.08	7.28	4.37	26.46
AOCH0260-70**	13.39	7.48	9.53	35.05
AOCH0400-70**	13.39	7.48	10.12	45.64

** 3 filters included, dimensions apply for one filter.



Sine filter options

ABB sine filter solution

The ACS800 sine filter solution is an ACS800 industrial drive equipped with a sine filter. It enjoys most of the premium features of the standard ACS800 industrial drive. The LC filter suppresses the high frequency components of the output voltage.

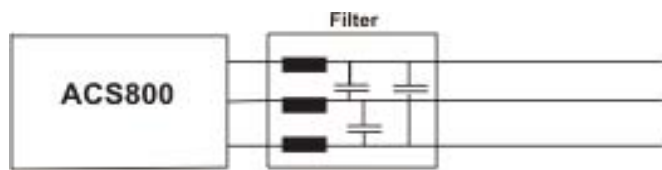

This means that the output voltage waveform is almost sinusoidal without high voltage peaks.

Filters are available in IP 00 degree of protection over the whole power range. The ACS800-U1 power range also has NEMA 1 filters available. The ACS800-U7/07 drive sine filters are complete cabinet-built units.

The ABB sine filter solution can be used in a variety of applications:

- Motor does not have adequate insulation for VSD duty
- Total motor cable length is long e.g. there are a number of parallel motors
- Step-up applications e.g. medium voltage motor needs to be driven
- Step-down applications
- There are industry specific requirements for peak voltage level and voltage rise time
- Motor noise needs to be reduced
- Maximum safety and reliability is needed in e.g. explosive applications
- Submersible pumps with long motor cables e.g. in the oil industry

Main features

- Optimized LC filter design that takes into account switching frequency, voltage drop and filtering characteristics
- Proven technology as ABB has delivered hundreds of sine filter solutions over the last 20 years in a wide range of applications.
- Cost effective solution
- Standard software has all the parameters that need to be set

Feature	Benefit	Note
Sinusoidal output voltage	No additional stress on the motor insulation: non-VSD compliant motors can be used, motor reliability and lifetime are maximized.	
	Allows the use of transformers in the drive output to match any required motor voltage.	Voltage drop at motor cable can be compensated with transformer i.e. there are no restrictions to motor cable length.
	Standard distribution transformer can be used in step-up solutions.	High starting torque is available with special transformer design.
	Less motor noise.	Usually the motor fan is the biggest noise source with sine filter solutions.
AP programming, advanced IR-compensation and flux control	The effects of load changes to motor voltage can be compensated i.e. the motor always has the optimum voltage.	Scalar control is required with sine filters.

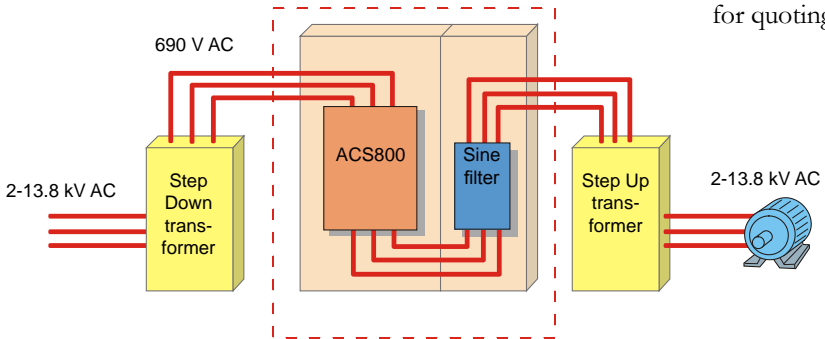

- Output current derating is required. Contact the factory for quoting.

Standard user interface

Control panel

The industrial drive control panel has a multilingual alphanumeric display (4 lines x 20 characters) with plain text messages in 14 languages.

The control panel is removable and can be mounted on the drive enclosure or remotely.

```
1 L -> 1242.0 RPM 1
SPEED 1242.0 RPM
CURRENT 76.00 A
TORQUE 86.00 %
```



Start-up assistant

Easy commissioning with the start-up assistant. The start-up assistant actively guides you through the commissioning procedure step by step. It also has a unique on-line help function.

```
MOTOR SETUP 4/10
MOTOR NOM CURRENT ?
(75.5 A)
ENTER: OK RESET: BACK
```

Actual value display

The control panel can display three separate actual values simultaneously.

Examples of these are:

- Motor speed
- Frequency
- Current
- Torque
- Power
- References
- DC bus voltage
- Output voltage
- Heatsink temperature
- Operating hours
- Kilowatt hours
- I/O status

Fault memory

A built in fault memory stores information relating to the last 64 faults, each with a time stamp.

```
1 L -> 1242.0 RPM 1
2 LAST FAULT
OVERVOLTAGE
1121 H 1 MIN
```

Parameter copying

Parameter copy feature allows all drive parameters to be copied from one frequency converter to another simplifying commissioning.

```
1 L -> 1242.0 RPM 1
UPLOAD <=<=<
DOWNLOAD =>=>=>
CONTRAST 4
```

Centralized control

One panel can control up to 31 drives.

```
-> -> <- ->
1 21 40 100
->
111
```

Easy programming

Parameters are organized into groups for easy programming.

```
1 L -> 1242.0 RPM 1
11 REFERENCE SELECT
3 EXT REF 1 SELECT
111
```

The ACS800 keypad is backward compatible to the ACS600.

Standard user interface

Standard I/O



Analog and digital I/O channels are used for different functions such as control, monitoring and measurement purposes (e.g. motor temperature). In addition, optional I/O extension modules are available providing additional analog or digital I/O connections.

Below are the standard drive control I/O of the ABB industrial drive for the Factory Macro. For other ACS800 application macros the default functions may be different.

Standard I/O on RMIO-01 Board

- **3 analog inputs:** differential, common mode voltage ± 15 V, galvanically isolated as a group.
 - One $\pm 0(2) \dots 10$ V, resolution 12 bit
 - Two $0(4) \dots 20$ mA, resolution 11 bit
- **2 analog outputs:**
 - $0(4) \dots 20$ mA, resolution 10 bit
- **7 digital inputs:** galvanically isolated as a group (can be split in two groups)
 - Input voltage 24 V DC
 - Filtering (HW) time 1 ms
- **3 digital (relay) outputs:**
 - Form C contacts
 - 24 V DC or 115/230 V AC
 - Max. continuous current 2 A
- **Reference voltage output:**
 - ± 10 V $\pm 0.5\%$, max. 10 mA
- **Auxiliary power supply output:**
 - +24 V $\pm 10\%$, max. 250 mA

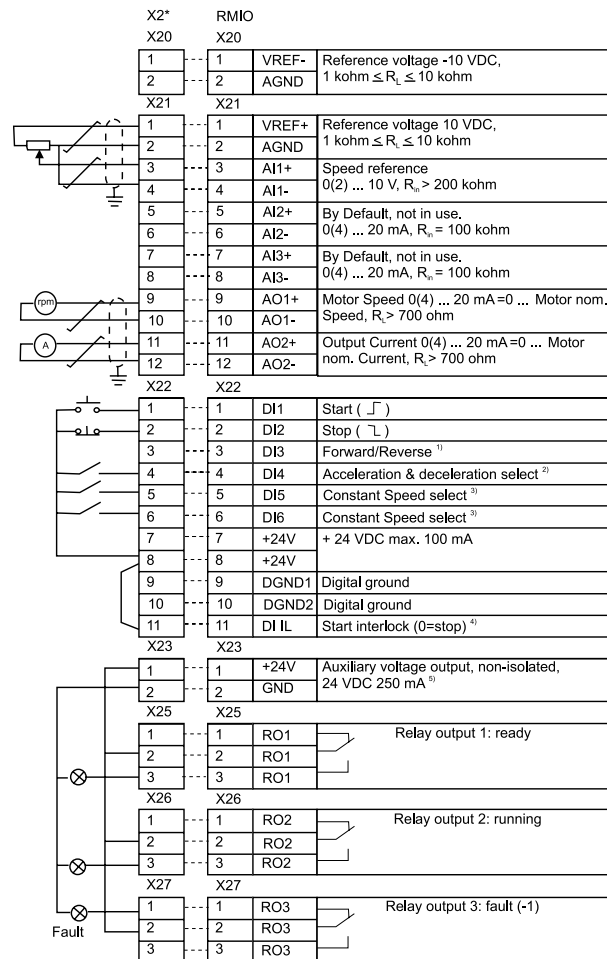
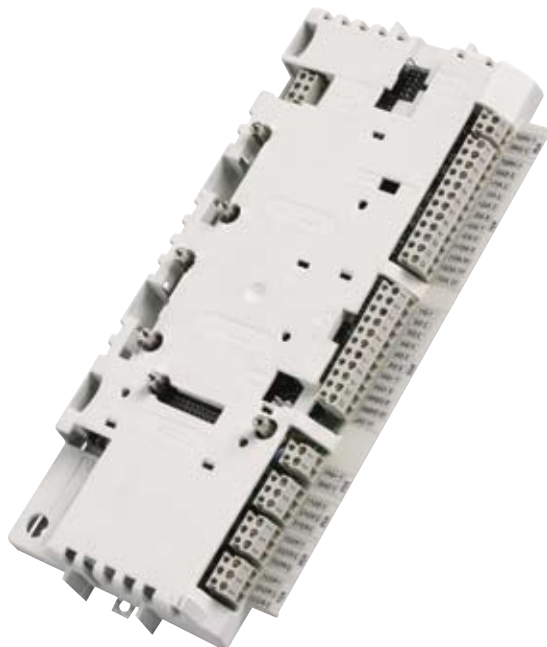

Additional I/O options

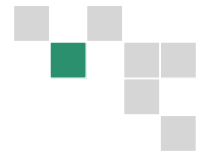

Standard I/O can be extended by using analog and digital extension modules or pulse encoder interface modules which are mounted in the slots on the ASC800 control board. The control board has two slots available for extension modules. More extension modules can be added with the I/O exten-

sion adapter which has three additional slots. The available number and combination of I/O's depends on the control software used. The standard application software supports 2 analog, 2 digital extension modules and 1 encoder interface module.

Optional I/O

Analog I/O extension module RAIO-01 (+L500)

- **2 analog inputs:** galvanically isolated from 24 V supply and ground
 - $\pm 0(2)\dots 10$ V, $0(4)\dots 20$ mA or $\pm 0\dots 2$ V, resolution 12 bits
- **2 analog outputs:** galvanically isolated from 24 V supply and ground
 - $0(4)\dots 20$ mA, resolution 12 bit

Digital I/O extension module RDIO-01 (+L501)

- **3 digital inputs:** individually galvanically isolated
 - Signal level 24 to 250 V DC or 115/230 V AC
- **2 relay (digital) outputs:**
 - Form C contacts
 - 24 V or 115/230 V AC
 - Max. 2 A

Pulse encoder interface module RTAC-01 (+L502)

- **1 incremental encoder input:**
 - Channels A, B and Z (zero pulse)
 - Signal level and power supply for the encoder is 24 or 15 V
 - Single ended or differential inputs
 - Maximum input frequency 200 kHz

Resolver Interface Module (Limited SW Support)



I/O extension adapter AIMA-01

- Three slots for I/O extension modules
- Connection to the ACS800 control board through fiber optic link
- Dimensions: $3.1 \times 12.8 \times 1.1$ in
- Mounting: onto 1.4×0.3 in DIN rail
- External power supply connection
- Supply voltage: 24 V DC $\pm 10\%$
- Current consumption: depends on connected I/O extension modules. (Recommend 1A 24 Vdc supply)

Communications options

Fieldbus control



ABB industrial drives have connectivity to most major automation systems. This is achieved with a dedicated gateway concept between the fieldbus systems and ABB drives.

The fieldbus gateway module can easily be mounted inside the drive. Because of the wide range of fieldbus gateways, your choice of automation system is independent of your decision to use first-class ABB AC drives.

Manufacturing flexibility

Drive control

The drive control word (16 bit) provides a wide variety of functions from start, stop and reset to ramp generator control. Typical setpoint values such as speed, torque and position can be transmitted to the drive with 15 bit accuracy.

Drive monitoring

A set of drive parameters and/or actual signals, such as torque, speed, position, current etc., can be selected for cyclic data transfer providing fast data for operators and the manufacturing process.

Drive diagnostics

Accurate and reliable diagnostic information can be obtained via the alarm, limit and fault words, reducing the drive downtime and therefore the downtime of the manufacturing process.

Drive parameter handling

Total integration of the drives in the production process is achieved by single parameter read/write up to complete parameter set-up or download.

Reduced installation and engineering effort

Cabling

Substituting the large amount of conventional drive control cabling with a single communication cable reduces costs and increases system reliability.

Design

The use of fieldbus control reduces engineering time at installation due to the modular structure of the hardware and software.

Commissioning and assembly

The modular machine configuration allows pre-commissioning of single machine sections and provides easy and fast assembly of the complete installation.

Currently available gateways

Fieldbus	Protocol	Device profile	Baud rate
PROFIBUS (+K454)	DP, DPV1	PROFdrive ABB Drives *)	9.6 kbit/s - 12 Mbit/s
DeviceNet (+K451)	-	AC/DC drive ABB Drives *)	125 kbit/s - 500 kbit/s
ControlNet (+K462)	-	AC/DC drive ABB Drives *)	5 Mbit/s
Modbus (+K458)	RTU	ABB Drives *)	600 bit/s - 19.2 kbit/s
Ethernet (+K466)	Ethernet/IP Modbus/TCP	ABB Drives *)	10 Mbit/s / 100 Mbit/s
ProfiNet (+K467)	Profinet IO Modbus/TCP	PROFdrive ABB Drives *)	10 Mbits / 100 Mbits
CANopen (+K457)	-	Drives and motion control ABB Drives*)	10 kbit/s - 1 Mbit/s
InterBUS-S (+K453)	I/O, PCP	ABB Drives*)	500 kbit/s

*) Vendor specific profile



Additional options

Remote monitoring and diagnostics tool



Browser-based, user-friendly

The intelligent ethernet NETA-01 module gives simple access to the drive via the internet, communicating via a standard web browser. The user can set up a virtual monitoring room wherever there is a PC with an internet connection or via a simple dial-up modem connection. This enables remote monitoring, configuration, diagnostics and, when needed, control. The drive can also provide process related information, such as load level, run time, energy consumption and I/O data, the bearing temperature of the driven machine, for instance.

This opens up new possibilities for the monitoring and maintenance of unmanned applications across a range of industries, for instance water, wind power, building services and oil & gas, as well as any application where the user needs access to the drives from more than one location. The NETA-01 also provides an opportunity for OEMs and system integrators to support their installed base globally.

No PC needed at local end

The intelligent ethernet module has an embedded server with the necessary software for the user interface, communication and data storage. This gives ease of access, realtime information and the possibility for two-way communication with the drive, enabling immediate response and actions, saving time and money. This is possible without using a PC at the local end, as required by other remote solutions.

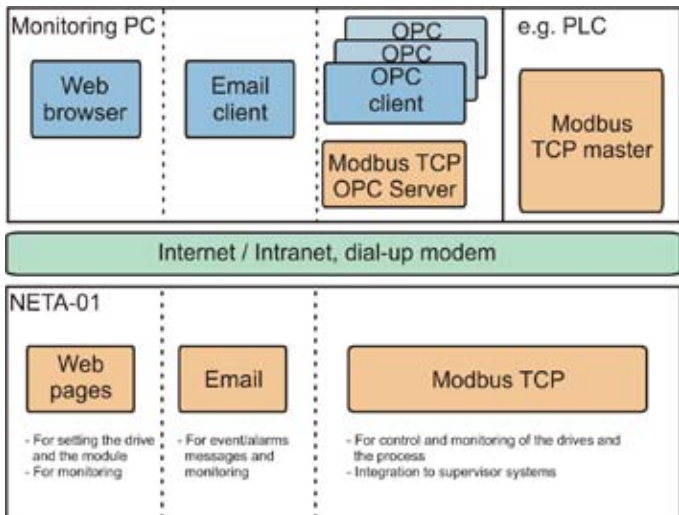

Powerful and versatile

Up to nine drives can be connected to the intelligent ethernet module via fiber optic links. It is available as an option for new drives, as well as an upgrade for existing systems. Access to the module is secured by user ID and passwords.

The intelligent ethernet NETA-01 module connects to the drive with fiber optic cables. The size of the module is 3.7(h) x 1.4 (w) x 3.0 (d) in

The web page of the module is opened like any other web address. The home page shows a general overview of the system with traffic lights and action buttons to guide the user through the different sections.

Features

- Virtual monitoring room for
 - Monitoring
 - Configuration of parameters
 - Diagnostics
 - Control, if needed
- Browser-based access via
 - Intra-/extra-/internet or
- Email Client
 - Event notification
 - Drive status update
- No PC needed at the local end
- Can be used as a Modbus/TCP bridge for process control
- The NETA-01 module may be used in conjunction with other Fieldbus modules from the previous page



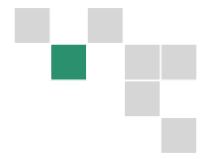

Standard application software

Based on ABB's exclusive Direct Torque Control technology, the ACS800 offers highly advanced features as standard. The ACS800 standard application software provides solutions to virtually all AC drives applications.

Adaptive programming

In addition to parameters, industrial drives have the possibility for function block programming as standard. Adaptive programming with 15 programmable function blocks makes it possible to replace relays or even a PLC in some applications. Adaptive programming can be done either by standard control panel or DriveAP, a user-friendly PC tool.

The standard application macros

The ACS800 features built in, pre-programmed application macros for configuration of such parameters as inputs, outputs and signal processing:

- FACTORY SETTINGS for basic industrial applications
- HAND/AUTO CONTROL for local and remote operation
- PID CONTROL for closed loop processes
- SEQUENTIAL CONTROL for repetitive cycles
- TORQUE CONTROL for processes where torque control is required
- USER MACRO 1 & 2 for user's own parameter settings

Software features

A complete set of standard software features offers premium functionality and flexibility.

- Accurate speed control
- Accurate torque control without speed feedback
- Adaptive programming
- Automatic reset
- Automatic start
- Constant speeds
- Controlled torque at zero speed
- DC hold
- DC magnetizing
- Diagnostics

- Flux braking
- Flux optimization
- IR compensation
- Master/follower control
- Mechanical brake control
- Motor identification
- Parameter lock
- Power loss ride-through
- Process PID control
- Programmable I/O
- Scalar control
- Speed controller tuning
- Start-up assistant
- Support for sine filter in the drive output
- Trim function
- User-selectable acceleration and deceleration ramps
- User adjustable load supervision/limitation

Pre-programmed protection functions

A wide range of features provides protection for the drive, motor and the process.

- Ambient temperature
- DC overvoltage
- DC undervoltage
- Drive temperature
- Input phase loss
- Overcurrent
- Power limits
- Short circuit

Programmable protection functions

- Adjustable power limits
- Control signal supervision
- Critical frequencies lock-out
- Current and torque limits
- Earth fault protection
- External fault
- Motor phase loss
- Motor stall protection
- Motor thermal protection
- Motor underload protection
- Panel loss

Optional application software

Control solutions for different applications



ABB provides a set of ready-made control solutions for specific industrial AC drive applications. Such software adds application-dedicated features and protection without an external PLC - improving productivity and reducing costs.

Main advantages of ABB's control solutions

- Application-dedicated features
- Improved production
- No external PLC
- User-friendly
- Easy to use
- Energy savings
- Smooth power loss ride-through
- Reduced costs
- Adaptive protection

Master/follower control

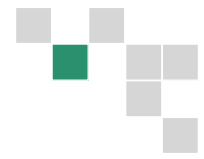
Reliable control via the fiber optic link of several drives when they are controlled by one master. This is needed e.g. if the motor shafts are coupled together. The master/follower function enables the load to be evenly distributed between the drives.

Pump control

Intelligent pump control software is a combination of traditional PFC which is specially designed for multi-motor pumping (or compressor, etc.) stations. While directly controlling one motor, the drive is able to start additional, direct-on-line motors whenever a higher capacity is needed.

Multipump function

Additional features such as the multipump function are designed for pumping stations that consist of multiple pumps, each controlled by a separate drive. The drives can be connected so that in the case of pump failure or maintenance action on one drive, the remaining drives continue operation - having 100% redundancy. There is an autochange function to alternate between the pumps so all pumps have equal operating time and wear.

Level control function

The liquid level of a container can be used as a process variable for a pumping station either filling or emptying the container when the level control function is activated. Three drives can be used in a master/follower configuration.

Flow calculation

The flow calculation contains a function that enables reasonably accurate calculation of flow without the installation of a separate flow meter.

Anti-jam function

The anti-jam function can be used for preventing solids from building up on pump impellers. The anti-jam procedure consists of a programmable sequence of forward and reverse runs of the pump, effectively shaking off any residue on the impeller.

Progressive Cavity Pump

Software to provide protection and optimization for Progressive Cavity Pumps and Electrical Submersible Pumps for the Oil and Gas industry. The software is designed to protect the pump rods from over torque situation during adverse conditions and provides safe shutdown through controlled backspin. It also provides for input from external sensors for further protection and returns feedback in pump terminology (rod speed and torque etc.).

Optional application software

Control solutions for different applications

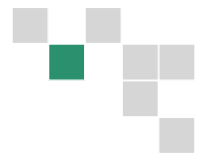

Centrifuge control

Practical programmable sequences for conventional centrifuges. Integrated decanter control for the accurate speed difference control of two shafts, where direct communication via the fiber optic link between bowl and scroll is used.

Crane drive control

Crane drive control with optimal operational safety and performance built into the drive.

- Easy installation and start-up reduces the total project costs
- Ready to use with proven crane functionality
- Accurate and fast response increases the operational productivity
- Multiple drives can be synchronized with internal fiber optic link, reducing the need for separate controllers. Everything needed is built in
- Available as single drive or multi-drive with dynamic and regenerative braking

Spinning control & traverse control

Spinning control and traverse control make a perfect pair for the precise control of spinning and traverse drives in textile machines.

Inline Control

The application software is designed for web process line Draw / Dancer / Tension control. An inline section on a process line is a section controlling the web in the machine after an extruder or unwind and before the winder or sheeter. This application program focuses on the converting and web handling industries and is commonly paired with the Center Winder/Unwind program.

- Draw Macro- Configures the drive to operate with manual speed adjustment from an operator control station.
- Dance Macro- Configures the drive to maintain setpoint dancer position based on dancer position feedback. The force on the dancer determines the tension on the web.
- Tension Macro- Configures the drive to maintain setpoint web tension based on a web force measurement device such as a loadcell. The ACS800 adjusts the speed of the the section to maintain the desired web tension.
- Master-Follower communications via fiber optics are supported for process line coordination

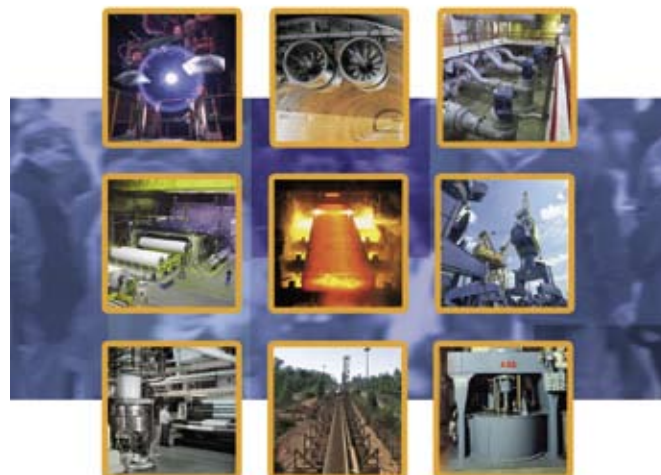

Optional application software

Control solutions for different applications

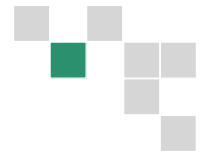

Center Winder/Unwind

The Center Winder/Unwind software is designed for process lines. The program supports tension control of a web using dancer trim, tension trim, or torque control. Included are a diameter calculator, tension regulators, inertia compensation, and roll change logic for continuous process lines. This application program focuses on the converting and web handling industries and is commonly paired with the Inline Control program.

- Draw Macro- Configures the drive to operate with manual speed adjustment from an operator control station.
- Dance Macro- Configures the drive to maintain setpoint dancer position based on dancer position feedback. The force on the dancer determines the tension on the web.
- Tension Macro- Configures the drive to maintain setpoint web tension by varying speed or torque of the section.
 - Closed Loop Tension Control uses a web force measurement device such as a loadcell. Based on the feedback value, the ACS800 adjusts speed or torque (setup option) to maintain set point tension.
 - Open Loop Tension Control operates in torque control mode and does not require a web force measurement device. The torque required to maintain setpoint tension is calculated from setup variables.
- Master-Follower communications via fiber optics are supported for process line coordination
- Built-in diameter calculator using web velocity and spindle speed to calculate actual diameter of the wound roll. The diameter calculation is used to trim the actual speed of the spindle axis as material is wound or unwound from the spindle thus maintaining accurate surface speed.
- Built-in inertia compensation with dynamic inertia adjustment based on actual roll diameter and web density
- Support for automatic roll change.

Position Control

ABB's Position Control Software provides an ideal solution for OEM machine builders and system integrators seeking to implement accurate position control in their applications. This software incorporates accurate positioning, synchronization, and DTC performance for position control applications. This software is designed to be an optimal solution to replace systems that implement sensors and PLCs as the main control apparatus for positioning systems.

This software offers four control modes:

- Speed & Torque control
- Position & Synchronization Control

These basic position control functions are included:

- Homing and Cyclic Corrections
- Gear functions for load, motor, and synchronization
- Selectable physical units for position values (mm, inch, increment, degree, and revolution)
- Probe latching through digital inputs

Additional Application Support

Extended I/O

An analog and digital I/O extension is typically installed on the AIMA-01 I/O extension adapters. Three extension modules can be installed on each I/O extension adapter and a fiber optic link connects the I/O extension adapters to the drive control board. The maximum number of I/O connections is 62.

Programming

Function blocks are easy to program using the DriveAP 2 PC tool. For example, there are PROFIBUS fieldbus blocks available to help users to understand the block program connections between the drive and Profibus master. Block program information, as well as text comments, symbolic names of block outputs and page header information is saved in the flash memory of the control board of the drive.

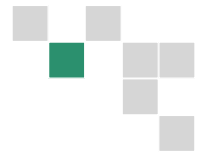

Quality dimensioning

DriveSize is a PC program for helping the user to select the optimal motor, frequency converter and transformer, especially in those cases where a straightforward selection from a catalog is not possible. Additionally it can be used to compute currents, network harmonics and to create documents about the dimensioning based on actual load. DriveSize contains the current versions of the ABB motor and frequency converter catalogs.

The default values make DriveSize simple to use, but the user is provided with ample options for drive selection. The shortcut keys make drive selection easy while giving the optimal dimensioning result. A manual selection mode is also supported.

DriveSize is currently used by more than 1,000 engineers globally.

DriveSize is for drive system components

- 3-phase standard, customized, and user defined motors
- ABB low voltage AC drives
- Transformers

DriveSize features

- Selects the optimal motor, drive unit, supply unit and transformer
- Calculates network harmonics for a single supply unit or for the whole system
- Allows importation of own motor database
- Supplies dimensioning results in graphical and numerical format
- Prints and saves the results

The DriveSize PC program can be downloaded from www.abb.com/motors&drives

- Drives
- Drive PC Tools
- DriveSize

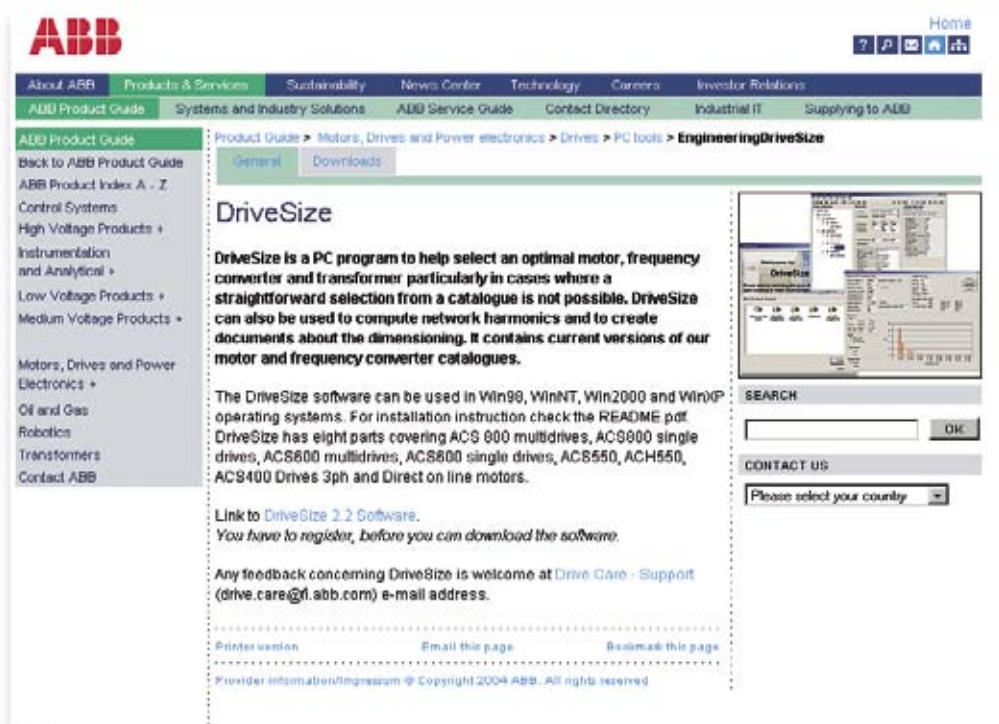

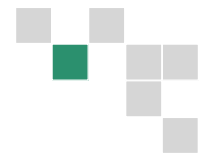

Programming tool

DriveAP is a PC software tool for creating, documenting, editing and downloading adaptive programs and multiblock programming programs. DriveAP 1.1 supports adaptive programming, whereas DriveAP 2 supports both adaptive programming and multiblock programming applications. The adaptive programming contains 15 function blocks and is available in a standard application. The multiblock programming application contains over 200 function blocks, and also includes PROFIBUS fieldbus and drive I/O blocks. DriveAP offers a clear and easy way to develop, test and document these programs with a PC.

It is a user-friendly tool for modifying function blocks and their connections. No special programming skills are required, a basic knowledge about block programming is enough. DriveAP supports IEC61131.

The adaptive programs are easy to document as hard copies or store as PC files. The multiblock programming with all related information is saved directly to the drive.

Upload or download

Both program types can be uploaded from connected drives and displayed graphically on a PC screen for service or documentation purposes.

The adaptive programs and multiblock programming programs made off-line can be downloaded to any of the connected drives that support corresponding programs.

Three operating modes

- Stand-alone mode - DriveAP is not connected to a drive. The adaptive programming and multiblock programming can be carried out in the office, for example, and later downloaded to a drive.
- Off-line mode - DriveAP is connected to a drive. The adaptive programming and multiblock programming can be carried out in batch mode.
- On-line mode - DriveAP is connected to a drive. Changes to the adaptive programs and multiblock programs are written immediately to the drive and actual values are shown on the screen in real-time.

DriveAP features

- Easy-to-use tool, no special skills required
- Create and download new programs
- Document programs
- Upload existing programs from the drive
- Operating modes
 - Stand-alone
 - Off-Line
 - On-Line

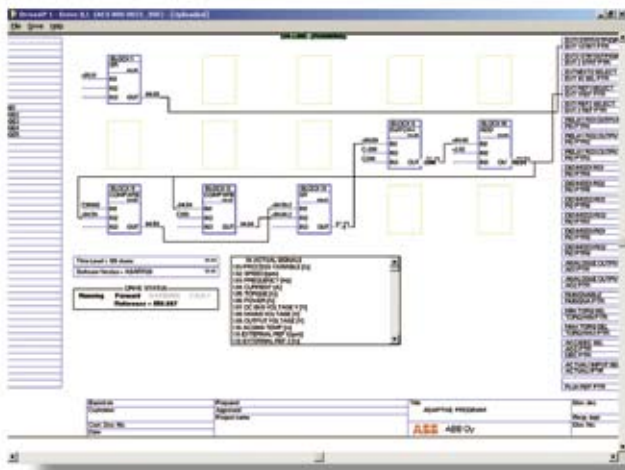

DriveAP with adaptive program of standard application.

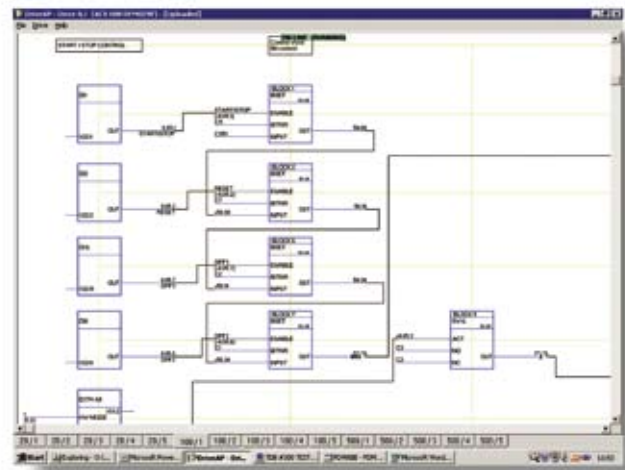

DriveAP with multiblock programming application.

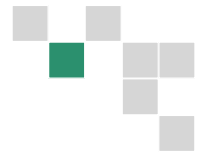

Start-up and maintenance tool

ABB's DriveWindow is an advanced, easy-to-use PC software tool for the start-up and maintenance of ABB industrial AC-drives. Its host of features and clear, graphical presentation of the operation make it a valuable addition to your system, providing information necessary for troubleshooting, maintenance and service, as well as training.

With DriveWindow the user is able to follow the operation of several drives simultaneously by collecting the actual values from the drives on a single screen or printout.

Additionally, the client part of DriveWindow may reside on one intranet PC, and the server on another PC closer to the drives. This enables easy plant-wide monitoring with two PCs.

High speed communication

DriveWindow uses a high-speed fibre optic cable network with DDCS communication protocol. This enables very fast communication between PC and drives. The fibre optic network is safe and highly immune to external disturbance. A fiber optic communication card inside the computer is needed.

Monitoring drives

With DriveWindow you can monitor several drives simultaneously. The history buffer makes it possible to record a large amount of data in the PC's memory. The drive's data logger can be accessed with DriveWindow and viewed in graphical form. The fault logger inside the drive automatically documents every fault, warning and event which occurs. The fault history stored in the drive can be uploaded to your computer.

Versatile back-up functions

Drive parameters can be saved to the PC with DriveWindow, and can easily be downloaded back to the drive whenever needed. The same goes for the software. DriveWindow allows the entire control board software to be saved and restored later, if needed. This makes it possible to use one control board as a spare part for many different sizes of drives.

DriveWindow 2 features

- Easy-to-use tool for commissioning and maintenance
- Several drives connected and monitored at the same time
- Monitor, edit or save signals and parameters, clear graphical presentation
- High speed communication between PC and drive
- Versatile back-up functions
- View data collected and stored in the drive
- Fault diagnostics; DriveWindow indicates the status of drives, and also reads fault history data from the drive

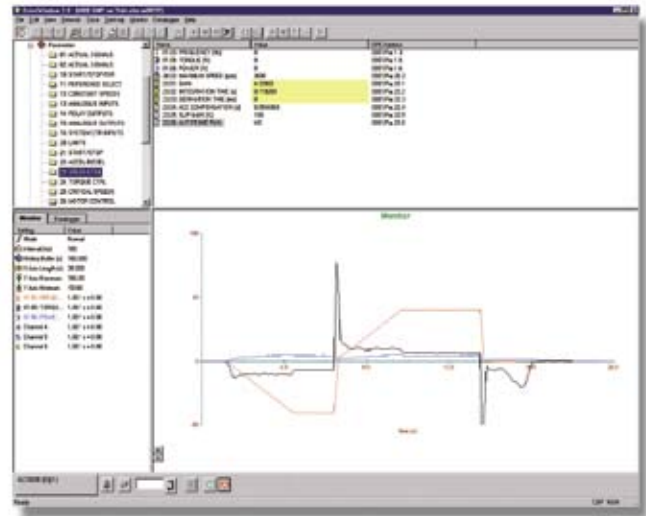

DriveWindow Light 2



Start-up and maintenance tool

DriveWindow Light 2 is an easy-to-use start-up and maintenance tool for ACS800 drives. It supports the following software: standard application, pump control, and spinning and traverse control. The DriveWindow Light 2 only supports drive frame sizes of R2-R8.

DriveWindow Light uses the drive's panel connector for communication, which makes communication setup very easy.

Light software with heavy features

DriveWindow Light offers many functions in an easy-to-use package. It can be used in an offline mode, which enables parameter setting at the office even before going to the actual site. The parameter browser enables viewing, editing and saving of parameters. The parameter comparison feature makes it possible to compare parameter values between the drive and the file. With the parameter subset you can create your own parameter sets. Controlling of the drive is naturally one of the features in DriveWindow Light.

With DriveWindow Light, you can monitor up to four signals simultaneously. This can be done in both graphical and numerical format. Any signal can be set to stop the monitoring from a predefined level.

Highlights

- Viewing and setting parameters in offline mode
- Editing, saving and downloading parameters
- Comparing parameters
- Graphical and numerical signal monitoring
- Drive control

DriveWindow Light requirements

- Windows 98/NT/2000/XP
- Free serial port from a PC
- Free control panel connector
- NPCU-01 PC connection unit (serial communications)

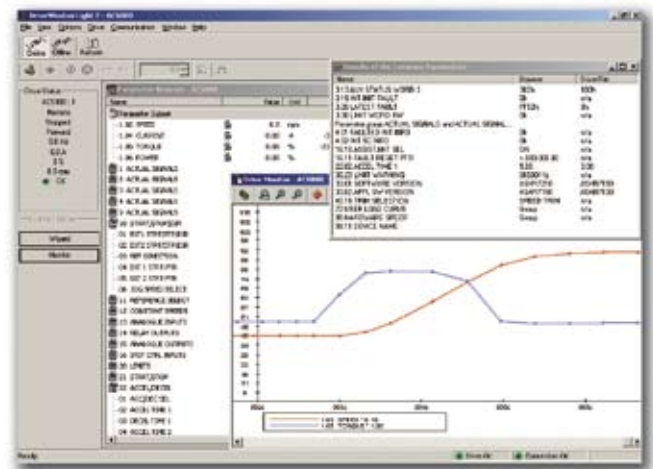

Summary of features and options



Power & voltage range	Ordering	- U1	- PC	- U2	- U7	- 07	- U11	- 17	- 17	- U31	- 37	- 37
	Code	R2-R6	R7-R8	R7-R8	R6-R8	nxR8i	R5-R6	R7i-R8i	nxR8i	R5-R6	R7i-R8i	nxR8i
230 V 500 V 690 V		.75 -75 2 - 150 5 - 100 Hp	150-600 Hp	125-600 Hp	75 - 600 50 - 550 Hp	550 - 2250 500 - 3000 Hp	7.5 - 60 15 - 125 Hp	150 - 500 150 - 450 Hp	550 - 2050 500 - 2550 Hp	7.5 - 60 15 - 125 Hp	150 - 500 150 - 450 Hp	550 - 2050 500 - 2550 Hp
Mounting												
Wall mounting		●	-	-	-	-	●	-	-	●	-	-
Free-standing		-	●	●	●	●	-	●	●	-	●	●
Cabling												
Bottom entry & exit	H350+H352	●	-	□	□	□	●	□	□	●	□	□
Top entry & exit	H351+H353	-	●	●	●	●	-	●	●	-	●	●
Enclosure Class												
IP 21 (UL Type 1)		●	●	●	●	●	●	●	●	●	●	●
IP 42 (UL Type 1)	B054	-	-	-	□	□	-	□	□	-	□	□
IP 54 (UL Type 12)	B055	-	□	-	□	□	-	□	□	-	□	□
IP 55 (UL Type 12)	B056	□	-	-	-	-	-	-	-	-	-	-
Motor Control												
DTC		●	●	●	●	●	●	●	●	●	●	●
Software 2)												
Start-up assistant		● ¹⁾	● ¹⁾	● ¹⁾	● ¹⁾	● ¹⁾	● ¹⁾	● ¹⁾	● ¹⁾	● ¹⁾	● ¹⁾	● ¹⁾
Adaptive programming		● ¹⁾	● ¹⁾	● ¹⁾	● ¹⁾	● ¹⁾	● ¹⁾	● ¹⁾	● ¹⁾	● ¹⁾	● ¹⁾	● ¹⁾
Optional software optimized for different applications or for enhanced programmability: for more details see section "Application software and programming"		□	□	□	□	□	□	□	□	□	□	□
Control Panel												
Alphanumeric 4*20 character control panel		●	●	●	●	●	●	●	●	●	●	●
Control Connections (I/O) and communications												
3 pcs analog inputs, programmable, galvanically isolated		●	●	●	●	●	●	●	●	●	●	●
2 pcs analog outputs, programmable		●	●	●	●	●	●	●	●	●	●	●
7 pcs digital outputs, programmable, galvanically isolated - can be divided into two groups		●	●	●	●	●	●	●	●	●	●	●
3 pcs relay outputs, programmable		●	●	●	●	●	●	●	●	●	●	●
Thermistor relay (1 or 2 pcs)	L505	-	□	□	□	□	-	□	□	-	□	□
Pt100 relays	L506	-	□ ²⁾	□	□	□	-	□	□	-	□	□
Possibility for external control voltage		●	●	●	●	●	●	●	●	●	●	●
Built-in I/O extension and speed feedback modules: for more details see section "Control connections and communications"		□	□	□	□	□	□	□	□	□	□	□
Built-in adapters for fieldbus: for more details see section "Control connections and communications"		□	□	□	□	□	□	□	□	□	□	□
EMC filters												
EMC 1 st environment	E202	□ ³⁾	-	□ ³⁾	□ ³⁾	□ ⁴⁾	□	□ ³⁾	□ ⁴⁾	□	□ ³⁾	□ ⁴⁾
EMC 2 nd environment, earthed networks only	E200	□ ⁷⁾	-	-	-	●	□	● ⁶⁾	●	□	● ⁶⁾	●
EMC 2 nd environment, earthed and unearthed networks	E210	□ ⁵⁾	● ¹⁰⁾	□	□	●	-	● ⁷⁾	●	-	● ⁷⁾	●
Line filter												
AC or DC choke		●	●	●	●	●	-	-	-	-	-	-
LCL		-	-	-	-	-	●	●	●	●	●	●
Output filters												
Common mode filter	E208	-	● ¹⁰⁾	□	□ ⁷⁾	●	-	□ ⁷⁾	●	-	□ ⁷⁾	●
du/dt filters	E205	X	X	X	□	●	X	□	●	X	□	●



Summary of features and options

Power & voltage range	Ordering	- U1	-PC	- U2	- U7	- 07	- U11	- 17	- 17	- U31	- 37	- 37
	Code	R2-R6	R7-R8	R7-R8	R6-R8	nxR8i	R5-R6	R7i-R8i	nxR8i	R5-R6	R7i-R8i	nxR8i
230 V 500 V 690 V		.75 - 75 2 - 150 5 - 100 Hp	150-600 Hp	125-600 Hp	75 - 600 50 - 550 Hp	550 - 2250 500 - 3000 Hp	7.5 - 60 15 - 125 Hp	150 - 500 150 - 450 Hp	550 - 2050 500 - 2550 Hp	7.5 - 60 15 - 125 Hp	150 - 500 150 - 450 Hp	550 - 2050 500 - 2550 Hp
Braking												
Brake Chopper	D150	□ ⁸⁾	□	□	□	□	-	-	-	-	□	□
Brake Resistor		X	X	X	X	X	-	-	-	-	X	X
Regenerative Braking		-	-	-	-	-	●	●	●	-	-	-
Rectifier Bridge												
12-pulse (can be connected as a 6-pulse also)		-	-	-	-	●	-	-	-	-	-	-
Low Harmonic IEEE519-1992 at input terminals		-	-	-	-	-	●	●	●	●	●	●
Adjustable Power Factor (Default = Unity)		-	-	-	-	-	●	●	●	●	●	●
Line Fuses												
aR line fuses	F260	-	-	□	□	●	-	●	●	-	●	●
gG line fuses	F251	-	●	●	●	-	-	-	-	-	-	-
Line side apparatus												
Main switch		-	●	●	●	●	-	●	●	-	●	●
Line contactor + emergency stop, category 0	F250+Q951	-	□	□	□	□	-	□	□	-	□	□
Air circuit breaker + emergency stop, category 0	F255+Q951	-	-	-	-	□	-	-	□	-	-	□
Air circuit breaker		-	-	-	-	-	-	-	●	-	-	●
Cabinet Options												
Control voltage 115 VAC ¹²⁾		-	●	-	●	●	-	●	●	-	●	●
Control voltage 230 VAC ¹²⁾	G320	-	-	□	□	□	-	□	□	-	□	□
Cabinet heater (ext. supply)	G300	-	-	-	□	□	-	□	□	-	□	□
Output for motor heater (ext. supply)	G313	-	-	-	□	□	-	□	□	-	□	□
Customized options	P902	-	-	-	□	□	-	□	□	-	□	□
Safety Options												
Prevention of unexpected start-up		-	-	-	□	□	-	□	□	-	□	□
Earth fault monitoring, earthed mains		●	-	●	●	●	●	●	□	●	●	□
Earth fault monitoring, unearthed mains		●	-	●	□	□	●	□	□	●	□	□
Emergency stop					(see Line side apparatus)							
Approvals												
CE Low Voltage Directive		●	-	¹¹⁾	¹¹⁾	¹¹⁾	●	¹¹⁾	¹¹⁾	●	¹¹⁾	¹¹⁾
CE, EMC		□ ¹¹⁾	-	□ ¹¹⁾	□ ¹¹⁾	□ ¹¹⁾	□ ¹¹⁾	□ ¹¹⁾	□ ¹¹⁾	□ ¹¹⁾	□ ¹¹⁾	□ ¹¹⁾
UL, cUL		● ⁹⁾	●	●	●	●	● ⁹⁾	●	●	● ⁹⁾	●	●
CSA		●	-	-	-	-	●	□	□	●	□	□
GOST R		¹¹⁾	-	¹¹⁾	¹¹⁾	□	pending	pending	pending	pending	pending	pending
C-Tick		¹¹⁾	-	¹¹⁾	¹¹⁾	pending	pending	pending	pending	pending	pending	pending

Notes:

- Standard
- Selectable option, built in
- X Selectable option, external
- Not available

- 1) Only in standard software.
- 2) Always 3 pcs.
- 3) Not for 690 V.
- 4) Only 0760-5.
- 5) Available for R6 only.
- 6) Selectable option, built in in frame size R6.
- 7) Not available for R6.
- 8) Standard in ACS800-U1 frame sizes R2 and R3 and at 690 V also in R4.

- 9) UL-type 1 only on Frame R5 and R6
- 10) Standard in R8 only, option in R7 frame
- 11) Different product type designations available to meet standard
- 12) Control voltage is for internal options only

Services and support

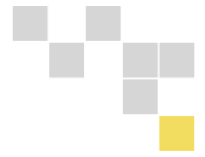

Global service network

ABB provides professional spare part, maintenance and repair services using its own authorized and certified service personnel as well as the personnel of the ABB channel partners all over the world.

Note: Though all services are available globally, local services may vary.

For more information on our ACS800 services and service network, please contact your local ABB representative.

Productized services

ABB's drive lifecycle management model provides customers with the maximum profit for the purchased assets by maintaining high availability, eliminating unplanned repair costs and extending drive lifetime. The lifecycle management model comprises many dedicated services for the entire lifecycle of ACS800 drives.

Start-up services

Using ABB's start-up services you can trust that your drives are correctly commissioned and tuned to their application. ABB global service network personnel are authorized professionals who are thoroughly trained for their job.

Training services

ABB offers dedicated training on ACS800 drives for your service and operating personnel for acquiring the required skills to use your ABB drives correctly and safely and to run the application in the most effective way.

ACS800 single drive training courses

Global Training

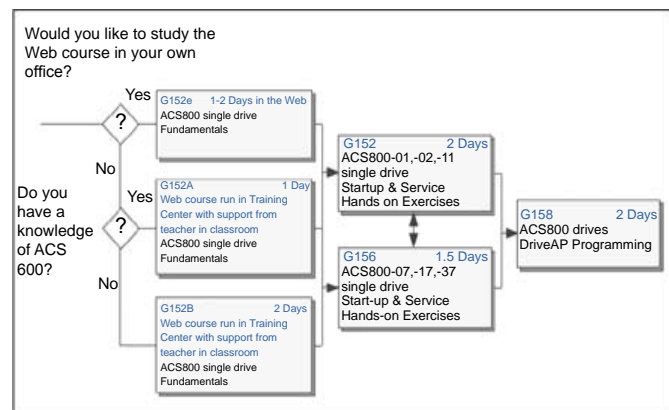

For more information on our training services, please contact your local ABB representative or visit the ABB University website: <http://www.abb.com/abbuniversity>.

US Specific Training

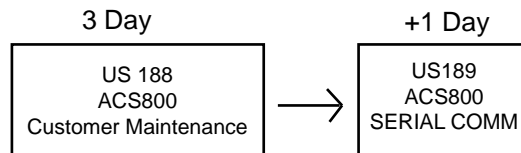

USA website: <http://www.abb-drives.com/training>

On-site spares kits

ACS800 drive on-site spares kits contain the most critical spare parts. You can choose your ACS800 drive spares kits from a separate table. If you do not have a copy, please contact your local ABB representative.

Notes:



Notes:



Notes:



Notes:



Contact and web information

For US support www.abb-drives.com

For Global support www.abb.com/motors&drives



ABB's worldwide presence is built on strong local companies working together with the local distributor and channel partner network across borders to achieve a uniform level of services for all our customers. By combining the experience and know-how gained in local and global markets, we ensure that our customers in all industries can gain the full benefit from our products.

For further details about all our variable speed drive products and services please contact your nearest ABB office or visit the ABB website: [http:// www.abb-drives.com](http://www.abb-drives.com)

Argentina (Valentin Alsina)
Tel: +54 (0)114 229 5707
Fax: +54 (0)114 229 5593

Australia (Victoria)
Tel: 1800 222 435
Tel: +61 3 8544 0000
Fax: +61 3 8544 0004

Austria (Vienna)
Tel: 0800 201 009
Tel: +43 1 60109-0
Fax: +43 1 60109-8312

Belarus (Minsk)
Tel: +375 172 236 711
Tel: +375 172 239 185
Fax: +375 172 239 154

Belgium (Zaventem)
Tel: +32 2 718 6313
Fax: +32 2 718 6664

Bolivia (La Paz)
Tel: +591 2 242 3636
Fax: +591 2 242 3698

Bosnia Herzegovina (Tuzla)
Tel: +387 35 255 097
Fax: +387 35 255 098

Brazil (Sao Paulo)
Tel: 0800 149 111
Tel: +55 11 3688 9282
Fax: +55 11 3684 1991

Bulgaria (Sofia)
Tel: +359 2 981 4533
Fax: +359 2 980 0846

Canada (Montreal)
Tel: +1 800 215 3006
Fax: +1 514 332 0609

Chile (Santiago)
Tel: +56 2 471 4391
Fax: +56 2 471 4399

China (Beijing)
Tel: +86 10 8456 6688
Fax: +86 10 8456 7636

Colombia (Bogota)
Tel: +57 1 417 8000
Fax: +57 1 413 4086

Croatia (Zagreb)
Tel: +385 1 600 8550
Fax: +385 1 6195111

Czech Republic (Prague)
Tel: +420 234 322 360
Fax: +420 234 322 310

Denmark (Skovlunde)
Tel: +45 44 504 345
Fax: +45 44 504 365

Estonia (Tallinn)
Tel: +372 6 711 800
Fax: +372 6 711 810

Finland (Helsinki)
Tel: +358 10 22 11
Tel: +358 10 222 1999
Fax: +358 10 222 2913

France (Champagne)
Tel: +33 (0)810 020 000
Fax: +33 (0)472 054 041

Germany (Lampertheim)
Tel: +01805 123 580
Tel: +49 (0)6206 503 503
Fax: +49 (0)6206 503 600

Greece (Athens)
Tel: +30 210 289 1900
Fax: +30 210 289 1999

Hungary (Budapest)
Tel: +36 1 443 2224
Fax: +36 1 443 2144

India (Bangalore)
Tel: +91 80 837 0416
Fax: +91 80 839 9173

Indonesia (Jakarta)
Tel: +62 21 590 9955
Fax: +62 21 590 0115
Fax: +62 21 590 0116

Ireland (Dublin)
Tel: +353 1 405 7300
Fax: +353 1 405 7312

Israel (Tirat Carmel)
Tel: +972 4 858 1188
Fax: +972 4 858 1199

Italy (Milano)
Tel: +39 02 2414 3792
Fax: +39 02 2414 3979

Japan (Tokyo)
Tel: +81(0) 3 5784 6010
Fax: +81(0) 3 5784 6275

Latvia (Riga)
Tel: +371 7 063 600
Fax: +371 7 063 601

Lithuania (Vilnius)
Tel: +370 5 273 8300
Fax: +370 5 273 8333

Luxembourg (Leudelange)
Tel: +352 493 116
Fax: +352 492 859

Macedonia (Skopje)
Tel: +389 2 118 010
Fax: +389 2 118 774

Malaysia (Kuala Lumpur)
Tel: +60 3 5628 4888
Fax: +60 3 5631 2926

Mexico (Mexico City)
Tel: +52 55 5328 1400
Fax: +52 55 5328 1482/1439

The Netherlands (Rotterdam)
Tel: +31 (0)10 407 8362
Fax: +31 (0)10 407 8433

New Zealand (Auckland)
Tel: +64 9 356 2170
Fax: +64 9 357 0019

Norway (Oslo)
Tel: +47 22 872 000
Fax: +47 22 872 541

Peru (Lima)
Tel: +51 1 561 0404
Fax: +51 1 561 3040

Philippines (Metro Manila)
Tel: +63 2 821 7777
Fax: +63 2 823 0309
Fax: +63 2 824 4637

Poland (Lodz)
Tel: +48 42 299 3000
Fax: +48 42 299 3340

Portugal (Amadora)
Tel: +351 21 425 6239
Fax: +351 21 425 6392

Romania (Bucarest)
Tel: +40 21 310 4377
Fax: +40 21 310 4383

Russia (Moscow)
Tel: +7 095 960 22 00
Fax: +7 095 913 96 96/95

Saudi-Arabia (Al Khobar)
Tel: +966 (0)3 882 9394
Fax: +966 (0)3 882 4603

Serbia and Montenegro (Belgrade)
Tel: +381 11 324 4341
Fax: +381 11 324 1623

Singapore
Tel: +65 6776 5711
Fax: +65 6778 0222

Slovakia (Banska Bystrica)
Tel: +421 48 410 2324
Fax: +421 48 410 2325

Slovenia (Ljubljana)
Tel: +386 1 587 5482
Fax: +386 1 587 5495

South Africa (Johannesburg)
Tel: +27 11 617 2000
Fax: +27 11 908 2061

South Korea (Seoul)
Tel: +82 2 528 2794
Fax: +82 2 528 2338

Spain (Barcelona)
Tel: +34 (9)3 728 8700
Fax: +34 (9)3 728 8743

Sweden (Västerås)
Tel: +46 (0)21 32 90 00
Fax: +46 (0)21 14 86 71

Switzerland (Zürich)
Tel: +41 (0)58 586 0000
Fax: +41 (0)58 586 0603

Taiwan (Taipei)
Tel: +886 2 2577 6090
Fax: +886 2 2577 9467
Fax: +886 2 2577 9434

Thailand (Bangkok)
Tel: +66 (0)2665 1000
Fax: +66 (0)2665 1042

Turkey (Istanbul)
Tel: +90 216 528 2200
Fax: +90 216 365 2944

United Kingdom (Manchester)
Tel: +44 (0)161 445 5555
Fax: +44 (0)161 445 6066

Uruguay (Montevideo)
Tel: +598 2 707 7300
Tel: +598 2 707 7466

USA (New Berlin)
Tel: +1 800 752 0696
Tel: +1 262 785 3200
Fax: +1 262 785 0397

Venezuela (Caracas)
Tel: +58 212 203 1817
Fax: +58 212 237 6270

Contact us

ABB Inc.

Low Voltage Drives
16250 W. Glendale Drive
New Berlin, WI 53151 USA
Phone: (800) 752-0696
Fax: (262) 785-0397
Web: www.abb.us/drives

ABB Inc.

Low Voltage Drives- Canada
3299 J.B. Deschamps Blvd
Lachine, Quebec H8T 3E4
Phone: (800) 215-3066
Fax: (514) 420- 3137
Web: www.abb.com

ACS800-PHTC01U-EN REV D Effective 08/15/2009 Subject to change without notice.

Power and productivity
for a better world™

